

illumina

lighting solutions

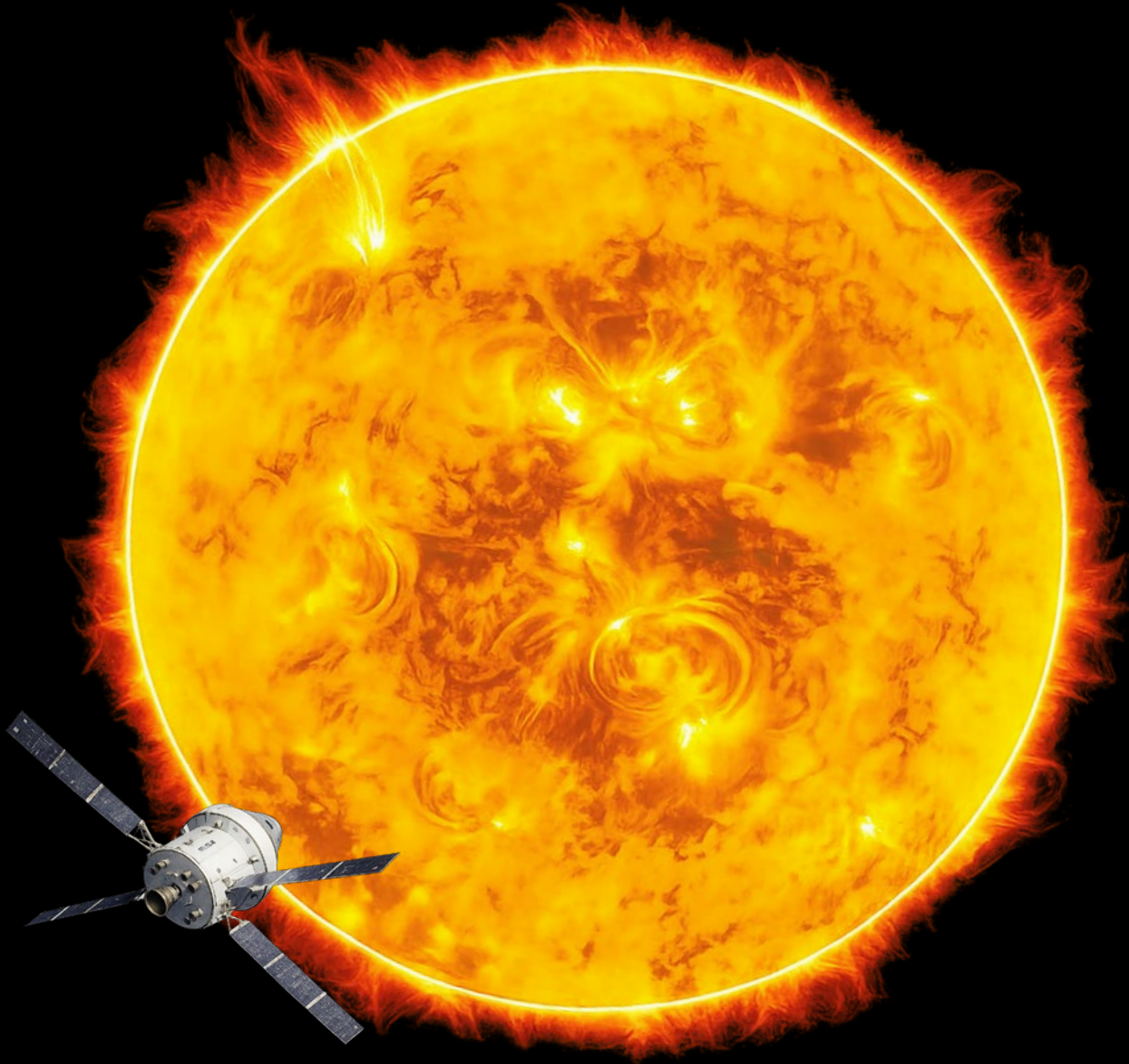

C/19.3

See a product you like and need more in-depth information?



For further information, technical details and downloads scan the QR code or visit www.illumina.co.uk/gridspot-anti-glare

Scan the QR code on the product page to find out more... /

OR type the web address into your browser /



What you will get... /

- Simple to use filters to get the **exact variant** you need
- Product demo videos to give you an understanding of the aesthetic and the scale
- Technical data sheets provide in-depth technical data
- Dimensional working drawings
- Installation images
- Images of all sizes

Colour temperature /

The colour temperature corresponds to the light colour of a light source and is measured in Kelvin (K) /

The higher the colour temperature, the cooler and bluer a white light source will look, the lower it is, the warmer it will appear:

2700K - Extra Warm White /

Similar feel to a traditional incandescent lamp. This colour is ideally suited to applications such as living rooms, bedrooms and restaurants.

3000K - Warm White /

Ideal for living areas, great for a cosy lighting atmosphere, giving a pleasant warm effect. This softer colour can be used in home lighting, galleries, retail stores, libraries and office areas.

4000K - Neutral White /

Great for general lighting, creating a cleaner, clinical, whiter light. This colour is often used in showrooms, leisure environments and office areas.

6000K - Pure White /

Pure white has blue tones and helps convey a sunny daylight type light that can be associated with pleasing outside conditions.

Colour rendering /

The colour rendering of a light source is an indicator of its ability to realistically reproduce the colour of an object /

The effect of a light source on the perceived colour appearance to the human eye is expressed in the colour rendering index. Commonly known as CRI, it is based on a scale of 0-100 with the top value of 100 based on illumination by a 100W incandescent light bulb.

The first digit in Illumina's colour temperature reference indicates the CRI, with the last two digits representing colour temperature, e.g. /930 would have a CRI of 90+ with a colour temperature of 3000K.

Lumen output /

Lumen output is a measurement of the total quantity of visible light emitted by a light source /

It's also commonly known as brightness or light output. The lumen output, combined with the beam angle, is a measure of light spread from the source. Broader beam angles will result in more spread-out light, but the lumen output will also be less intense. Alternatively, narrower beam angles will have less spread but a higher light intensity.

about **illumina** / our philosophy is simple

With over **40 years** of lighting experience, we understand that design, quality and service must underpin all that we do.

Illuma Lighting is part of a specialist lighting group, established in 1945, with over 150 employees in the UK /



illumina /
about illumina

Illuma is a leading lighting manufacturer situated in Castle Donington, UK, at the heart of the East Midlands /

With a focus on serving both domestic and export markets, the company provides innovative lighting solutions for retail, commercial, and leisure applications.

Illuma takes great pride in its commitment to producing cutting-edge products that offer exceptional technical, aesthetic, and photometric performance while remaining affordably priced. In addition to its portfolio of award-winning contemporary lighting products, **Illuma** is well-known for providing outstanding customer service.

With a reputation for industry-leading support, the company boasts impressive levels of performance, regularly achieving **99%+ OTIF** rates on standard product deliveries.

Illuma stands behind the quality of its products, offering a **5-year** guarantee on all purchases, as well as comprehensive after-sales support services.



Our products /
are rigorously tested to the
highest standards, both internally and
externally to give you confidence
in our **5 year** guarantee.



Daniel
Hamburger /
Managing Director



Eric Riley /
Sales & Marketing Director



Quality + compliance

illuma lighting /
is **committed** to providing
high quality lighting products
that conform to the highest
standards, meeting all
regulatory requirements.



The UKCA marking /
is the applicable product marking regulation
in **Great Britain** (England, Scotland, and Wales)
to replace the **CE** marking for goods being
placed on the market.

It is a mandatory requirement for products
sold in the **UK** and signifies that the product
conforms to the relevant **UK regulations**,
safety standards, and conformity
assessment procedures.



All of our products /
we test all of our products for **CE** conformity
to demonstrate compliance with **European
Union (EU) safety**, performance, health, and
environmental protection standards.

CE marking is a mandatory conformity marking
for products sold within the **EU**, indicating that
they meet the minimum legal requirements.

For our customers, **CE** marking means that they
can have confidence in the safety, quality and
performance of our products.

Sustainable compliance /



with the WEEE directive requires all producers and importers to take responsibility for treating and recycling all electrical equipment at the end of their useful life /

Via Ecosurety, Illuma has put in place a comprehensive system for the collection and disposal of our non-household lighting equipment. This includes the removal of all non-recycled and non-recyclable packaging from all our products.



Our goal is to achieve carbon neutrality, by 2030, which means that we aim to balance the amount of carbon dioxide emissions we produce with an equivalent amount of carbon removal or reduction measures /

This commitment is crucial to addressing climate change and creating a sustainable future for generations to come.

Conformance /

Illuma are NQA accredited with ISO 9001:2015. We operate within a structured framework, managing and improving processes, reducing costs through efficiency, and enhancing customer satisfaction /

Our ISO 9001 quality system helps us to identify and mitigate risks, prevent problems, and improve our reputation and competitiveness.

We aim to deliver consistent, high-quality products and services while enhancing our operational and financial performance.

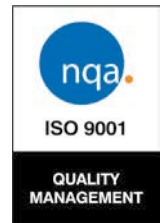

Policies /

We have implemented comprehensive policies addressing environmental sustainability, achieving zero emissions, combatting modern slavery and promoting equal opportunities /



Environmental



Modern slavery



Equal opportunities



Net Zero

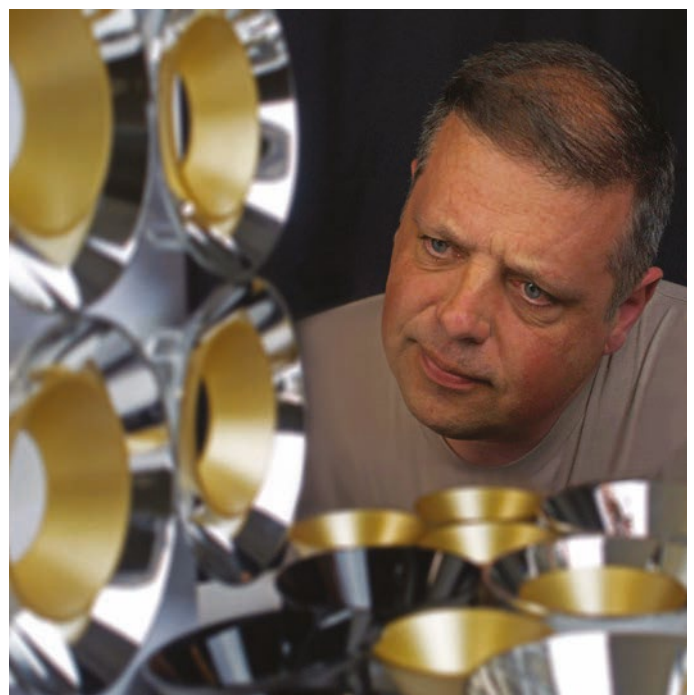

illumina

Design + development

As a leading lighting manufacturer, we take pride in our commitment to **excellence** in design.

We understand the importance of not only creating visually appealing lighting fixtures / but also ensuring they **perform** to the highest standards.



Product design /

We are proud to boast an experienced UK product design team / ensuring cradle to grave **design support** to maximise performance and reliability.



UK

Manufactured / on site in Castle Donington and **100% tested** to ensure best in class quality and compliance.

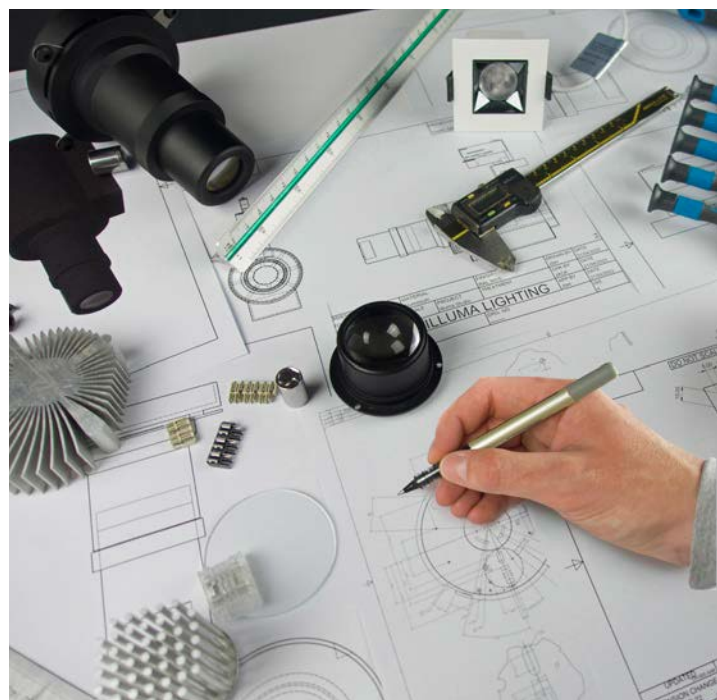



Lighting performance /

At **Illuma**, we believe that exceptional lighting performance and compliance is essential / We are a proud member of the Lighting Industry Association and have been since its inception.

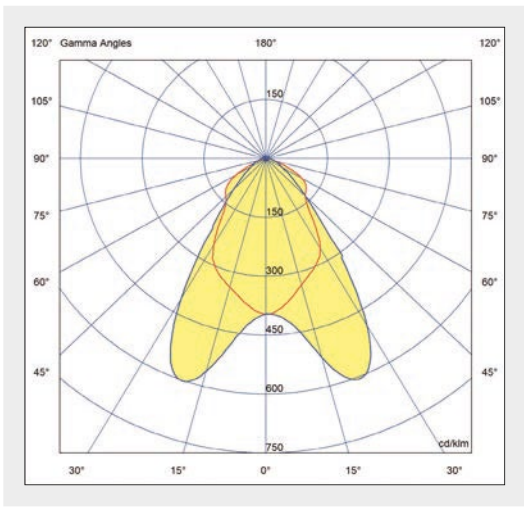

Efficacy / lm/W

Referred to as a **lm/W** (lumens per watt) value, details the performance of a light source in turning power into light / The higher the value, the more efficient the product is. **Illuma** quotes total system efficacy to provide our customers with accurate and truthful data for their entire system, not just the LED.



5yr /

With onsite facilities and testing capabilities / we are confident enough to offer **5 year** guarantee on all of our products.



We take regulatory compliance seriously / and make sure our products meet all relevant **regulations**, including safety and performance standards.



Lighting standards /

All new products are rigorously tested in our UK laboratory / to ensure all the latest **British Standards** are met, including BE EN IEC 60598-2022 + A11:2022 & BS EN 61000.

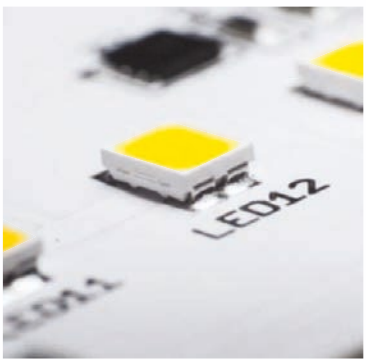

The **team** / The **people** behind illumina are as important as the company itself.



We're a diverse family at Illuma with years of lighting industry experience /
Illuma are an agile group of expert lighting designers, marketers, product developers, quality control engineers, technical experts, project managers and sales executives with a shared commitment to communication, collaboration and delivering the best lighting solutions.



LED and colour consistency /

Our light engines utilise the **highest quality** LEDs and circuitry to eliminate colour variations from one fitting to the next. We aim to deliver superior LED colour consistency across our entire range.



High stock holdings & next day delivery /

We maintain **extremely high** levels of components and finished item stock in our 120,000ft² UK warehouse. Next-day delivery is available on a wide range of standard products.

Specifically designed optics /

Unique lighting solutions require specifically designed optics to **maximise** a products performance and efficiency. We pride ourselves on our product innovation, design and portfolio of award-winning products.



Customisation /

At **Illuma**, we recognise the importance of specialisation. Not every application is suitable for an off-the-shelf solution, that's why we go to great lengths to ensure that the environment you envisage is the effect you achieve.



High CRI values /

Our LED luminaires have **high CRI values** up to 98 CRI meaning they can produce excellent colour rendering.

ISO 9001 registered company /

We at **Illuma** are committed to delivering the best lighting solutions and maintaining our excellent reputation whilst meeting the needs of our clients. **Illuma** is an ISO 9001-accredited company.

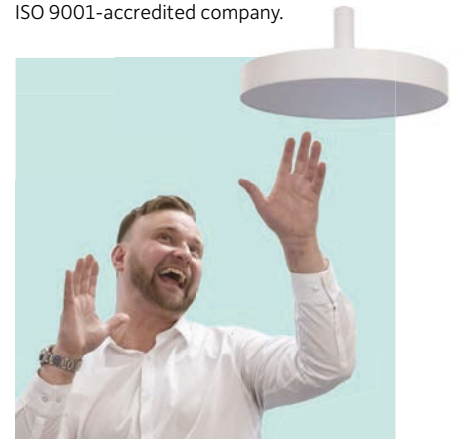



FREE lighting design service /

Our in house team of **LIA qualified** Lighting Designers use the latest lighting design software to provide clients with a complete lighting design proposal.

Flicker free dimming /

We offer a variety of **flicker free** dimming solutions. Controlling the light levels of a space not only brings about energy savings but can dramatically affect the mood and ambience of a space.



illumina / about / the-team



Quality assurance & 5-Year guarantee /

We **build and maintain** strong relationships by supporting clients every step of the way. We are so committed to quality that the entire range is supported by our renowned 5 year guarantee.

Design for ease of installation /

All **illumina** products are designed to consider both the installer and installation process. Simplifying and saving time during installation ensures that solutions are fitted within tight project time frames.



Professional reputation /

Our **illumina** external sales team are fully trained and conversant in everything lighting. They have a high level of experience and understand the project process from start to finish.



Future-proof lighting solutions /

We have created a **portfolio** of flexible lighting solutions that are future-proof. Consistent spotlight mounting options and track systems allow clients to add and remove fittings at their leisure, reducing costs and maintenance.

Energy efficient lighting solutions /

We use only the **latest technologies** and materials to offer some of the most energy efficient lighting solutions on the market, all with a high luminous efficacy.

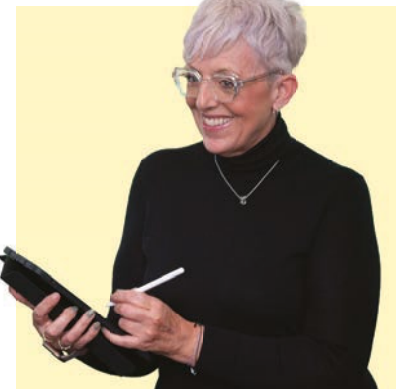

Family business /

We are a **proud family business**, established 40+ years ago. We have an in-depth experience in the commercial lighting industry dealing with Architects, Interior Designers and Electrical Consultants, through to Electrical Distributors and Electrical Contractors.

Lighting design /

Our lighting designs are all about creating atmosphere and ambience alongside the practical application of light.

Lighting should not just be seen as a functional solution, but instead as an intrinsic part of the experience.



illumina /
lighting design



Services you can expect /



We combine our technical knowledge with an understanding of how light can transform or amplify the mood of a space. We don't settle for anything less than quality, and our accurate, detailed design work gives our customers a real feel for what they can achieve with **illumina**.

James Sesin, *Lighting Designer*
at **illumina** Lighting.



Technical advice

On suitable
products
and design
layouts /

Lighting design timeline / How to deal with us...

Contact **illumina** and speak to one of our experienced lighting professionals.



Arrange a **site visit** and product demonstration to gather project details.



Our in-house **LIA** certified lighting design team put together a full lighting **design & schedule**.



01



HD 3D

walkthroughs

Help you to envisage the final outcome /



LUX

calculations

Accurate readings to give you confidence in the Illuma solution /



Detailed

3D renders

We create high quality raytracing images to help you see your project come to life /



Process Gallery 3D render /



Process Gallery completed project /

Receive and review the design then discuss any changes with the team.



4

Request a quotation.



5

See your lighting design come to life.



6

Our services / We're here for you **every step** of the way.

We build and maintain
strong relationships by
supporting our clients
at every stage.



Our in-house design and product development teams are dedicated to maintaining quality throughout our operations /

This **commitment** is evident from the sourcing of the latest and highest quality materials to the design of the most innovative and award-winning products in the industry.



At **illumina**, we merge technical expertise with a deep understanding of how light can enhance and influence the ambience of a space /

Our unwavering commitment to **quality** ensures that we never settle for anything less than excellence. Through our meticulous and precise design work, we provide our customers with a tangible sense of what they can achieve with **illumina**.



illumina offers exceptional levels of service /

We strive to ensure that all bestselling products are always in stock, with **over 95%** of all SKUs stocked at around 10 weeks' inventory level. This allows us to dispatch over **80%** of orders complete on the same day that they are received. The remaining 20% are dispatched within 10 days, or in the case of special products, within the quoted lead time.

Through investments in research and development, manufacturing, distribution, human capital, and training, **illumina** is well positioned to respond to the changing needs of our marketplace.



Our technical expertise is backed by **Illuma's** team of experienced Lighting Designers who are **LIA** qualified /

They use the latest lighting calculation and design software to provide clients with a comprehensive and complete lighting design proposal, free of charge. **Illuma** adheres to agreed application guidelines, reports, and architect/site layouts, while creating dynamic and intelligent lighting designs that maximise the impact and efficiency of our products.

Unique lighting solutions require a unique team with the technical knowledge to drive our business forward and source better solutions for the increasingly demanding environments and market conditions around the world.



Illuma is committed to equal opportunities /

As an employer, we strive to create a **challenging** working environment in which personal fulfilment, job satisfaction, and continuous quality improvement are actively pursued by all staff.



Sustainability /

is a key consideration for **Illuma**, as we are mindful of the potential impact that our business activities could have on the global environment. To minimise this impact, we use recyclable materials wherever possible and work in partnership with our subcontractors and external suppliers to reduce our environmental footprint. In addition to complying with the guidelines of **WEEE**, **EuP**, **REACH** and **RoHS**, we also explore the latest technologies to make our products more energy-efficient and reduce their carbon emissions.

Illuma is proud to be a member of **Ecosurety**, the UK's leading producer responsibility compliance scheme that is making a positive contribution to recycling in the country.



Web resources + support /

Our web resources provide an in-depth knowledge bank of all our products and the latest support articles.

View some of our latest online support articles... /



LED drivers & power supplies guide /



Dimmability guide /



Emergency lighting guide /



IP Ratings & ingress protection guide /



Fire rating guide /



Lamp table guide /



Wall mounting spotlights guide /

Case studies /

Learn how some of **Illuma's** most notable customers used our lighting solutions to deliver exceptional experiences to their visitors and transform their environments.



Liverpool FC Shop

Retail /

With over **40 years of experience** in the lighting industry, we have successfully implemented many multi-national rollouts for big name brands. We work with many retailers on all aspects of their lighting and are experienced in all areas of retail.



Taunton School Chapel

Religious buildings /

Illuma have worked with a variety of clients on lighting places of worship and understand that these kind of applications need to be guided by the architecture and the nature of the worship within the building.



Southampton University

Education & schools /

Our **wide range** of LED luminaires offer low energy lighting solutions for educational applications and can create substantial savings. We understand that unique areas require specialised lighting solutions.



Bala Bay / London

Eating & drinking /

Illuma have a history of working with some of the most recognisable brands from across the eating & drinking industry. We aim to dramatically transform the aesthetics and possibilities of how a space is illuminated.

See our latest project installations throughout this brochure, or go online / **Illuma** products have featured in a number of prestigious lighting schemes including; **Universal / Disney / Selfridges / Harvey Nichols / Timberland / Next / BMW / Adidas / Nike / Liberty's / Halfords / Superdry / Caffè Nero / Crew Clothing / Greggs / Seasalt / TUI / The Tate Edit / Tortilla / Louis Vuitton** and **Pandora** to name a few.

illuma / projects /
case studies



Bradgate Park Visitor Centre

Art galleries & museums /

Art gallery & museum lighting needs to fulfil a variety of specifications. Our range of luminaires are perfectly suited for these **ever-changing** environments, providing flexibility and highlights for dramatic effect.



Bankside / London

Commercial offices /

Using all our **lighting expertise** we are able to transform any commercial & office space into a dynamic work environment. As no two projects are the same, we tailor our service to fulfil ambitious design briefs.



Tate Edit / London

Entertainment & leisure /

Illuma's products have featured in a number of entertainment & leisure lighting schemes across the world. Our award winning portfolio of contemporary lighting is ideal for such applications.

Industry spotlight / Sheppy's Cider

located in Somerset, is a stunning example of restaurant and retail lighting at its best.



Illuma wanted to help Sheppy's create a flagship environment to promote their brand by installing a brand new lighting scheme.

To do this, the aim was to dramatically increase the lux levels in the main area of the visitor centre - particularly over produce - to entice customers to make a purchase. Emphasis was also placed on making the bar and restaurant areas darker to create a more seductive, cosy atmosphere.



Sheppy's are one of the oldest premium craft cider making families in the world with a history that goes back more than 200 years /

Sheppy's new 'House of Cider Visitor Centre' brings together a butchery, deli, and cafe stocked with the finest locally sourced produce. Visitors can also explore their full range of award-winning craft ciders and even book a guided tour or tasting event to discover some of Sheppy's oldest cider-making secrets.

At the start of this exciting project, **illumina** were asked to propose a series of lighting designs for Sheppy's. The opportunity to work closely with such an exciting and historic British brand in revamping their visitor centre, was one that excited all involved. The final lighting scheme for Sheppy's Cider used a variety of luminaires including the **Gridspot** & **Floodline** combined with **Twizzle** downlighters.





01

✓
Vibrancy
& brightness
was **required** around
the butchery, deli
and cafe areas.



vibrant
+ functional

The Solution / When **Sheppy's** first approached **Illuma** they knew what type of environment they wanted to create but didn't know how to achieve it. With over 40+ years lighting experience this is where **Illuma** were able help to transform **Sheppy's** rough ideas into real life working solutions.

Industry spotlight / Bechstein Pianos

in Manchester, boast a superb mix of showroom, practice and teaching studios.



The ability of the Prospots to be dimmed using DALI was a crucial factor for the showroom. It was essential for them to adjust the lighting and ambience in the room especially for the stage area in which guest pianists can come and perform to a seated audience. Linear track runs were also designed to create drama and depth in the showroom, and extra flexibility with all areas being covered by the carefully planned track layout.



C. Bechstein, a renowned manufacturer of premium upright and grand pianos, was founded in Berlin in 1853 /

Their instruments are known for their outstanding and rich sound, captivating generations of pianists and music lovers for over 150 years.

illumina was approached to create a comprehensive lighting design proposal for Bechstein's showroom in Manchester, which is currently the only official Bechstein showroom in the country. The opportunity to collaborate with such a historic brand and enhance the beauty of the exquisite pianos was one that certainly excited illumina's lighting design team.

The objectives were to achieve the appropriate lux levels to accentuate the instruments in the primary showroom and practice rooms. This would not only enhance their appearance but also enable pianists to play with precision.

Additionally, there was a need to showcase a mural on the stone wall and ensure that the space was flexible and capable of accommodating future requirements.

To achieve this, throughout the main showroom illumina used the DALI Dimmable Prospot, paired with linear runs of Control Track. The Prospots' high CRI (Colour Rendering Index) and lumen performance made it the ideal choice to emphasise the wood grains in the space and add a 'wow factor' to the pianos.

Another area of focus for illumina was the practice rooms. These are six purpose-built, sound insulated practice and teaching studios available to hire. The Infinia Silver cone were used in here which provide a comfortable amount of light to be able to accurately practice and teach whilst the silver cone gives the room a classy finish and aesthetic.

Finally, a mural depicting Sir Stephen Hough CBE, a British-born classical pianist, composer, and writer, was highlighted using the Linia Blade S Wallwash. illumina utilised this luminaire to uniformly wash the stone wall with a neutral white kelvin temperature, creating a contrast with the warm white ambient lighting to make the mural stand out and become an impressive focal point.

The representatives from C. Bechstein have expressed their delight with the illumina products and solution – so much so that illumina are now being specified and are working towards their latest C. Bechstein flagship store in London W1 which is due to be opening early 2024.





01

✓
Soft & seductive lighting was required in the practice and teaching studios.



grand + exquisite

The Solution / When Bechstein approached Illuma they had a vision of the environment they wanted to create but didn't know how to achieve it. With over 40+ years lighting experience this is where Illuma were able help to bring new light to Bechstein's flagship showroom.

Contents

Spotlights

28-59

Pages



Torp 30



Concepta 32



Gridspot 34



Probeam Frame 44



Probeam 46



Rotaspot 48

Linear

60-83

Pages

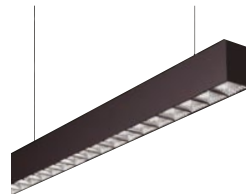

Linia Blade S 62



Linia Blade R 66



Linia Blade T 68



Revolva 76



Biline 78



Linia 80

Track systems

84-95

Pages



CLEVR 88



1-Circuit Track 230V 90



3-Circuit Track 230V 92

Project downlights

96-115

Pages



Twizzle 98



Project 90 Open 100



Project 90 Cone 102



Gridspot Anti-Glare **36**



Chameleon **38**



Probeam Select **40**



Robospot **42**



Lumapar **50**



Lumapar GU10 **52**



Rocket E27 **54**



Topspot E27 **56**



Marktrack **58**



Floodline **70**



Quadroled Linear **72**



Quadroled **74**



Linkline **82**



3-Circuit Track
230V Recessed **93**



Control Track
230V **94**



Control Track
230V Recessed **95**



Project 90 Gimbal **104**



Project 90 Wallwash **106**



Framelight Mini **108**



Proseal F **110**



Project 50 **112**

Contents *continued*

Project downlights

96-115

Pages



Firehoods 114

Commercial downlights

116-141

Pages



Hexseal 118



Infinia 120



Infinia Mini 124



Highlux Gimbal 132



Highlux Surface 134



Twinlux Low-Glare 136

Feature

142-159

Pages



Ambit 144



Uniseal 146



Zube Pendant 148

Exterior

160-169

Pages



Signspot 162



Signled 164

Emergency

170-181

Pages



Emlux Duo 172



Emlux Twinspace 174



Emlux Discrete 176



Arc 126



Framelight 128



Highlux Fixed 130



Lightseal 138



3D Ceiling Adaptor Ring 140



Zube Pendant Shades 150



Disk Pendant 152



Disk Wall 154



Upline 156



Via 158



Pathfinder 166

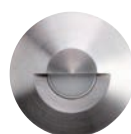

Camino 168



Emlux Blade 178



Emlux Sign 180



Emlux Bulkhead 180



Emlux Sign 180

Mounting options

Track adaptor dimensions (mm):



Track adaptor colours:



Note: All Chrome spotlights are supplied with a **Black** Track Adaptor / Surface Mounting Plate / Pendant Stem.

1-Circuit Switched Track Adaptor

230V
16A
For use with Illuma 1-Circuit 230V Track / (see page 82).



ON / OFF switch for flexibility



Sliding adaptor lock

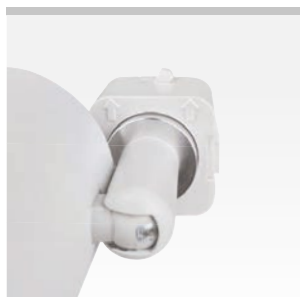

Why the arrows – see page 83

1-Circuit Multi (Global Trac Base) Track Adaptor

230V
16A
For use with Global Trac Base 1-Circuit Track /

Concord Lytespan 1 & Lytespan LP tracks (Note: not compatible with Illuma 1-Circuit 230V Track).



Universal adaptor



Adaptor locking lever



Slim profile

3-Circuit Switched (Global Pro) Track Adaptor

230V
16A
For use with Illuma 3-Circuit 230V Track / (see page 84).

3-Circuit 230V Recessed Track / (see page 84) & many other European brands.



3-Circuit selector inc. OFF



Adaptor locking lever



Slim profile



3-Circuit Switched Casambi Track Adaptor

230V
16A For use with Illuma 3-Circuit 230V Track / (see page 84).

3-Circuit 230V Recessed Track / (see page 84) & many other European brands.

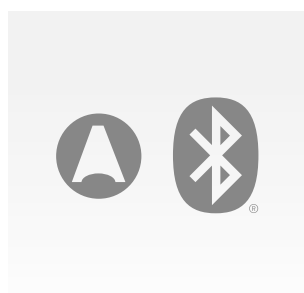

Casambi dimmable / Bluetooth®



3-Circuit selector inc. 0 for OFF



Adaptor locking lever



3-Circuit Control Track (Global Trac Pulse) DALI Track Adaptor

230V
16A For use with Illuma Control Track 230V / (see page 86).

Control Track 230V Recessed / (see page 86) & many other European brands.

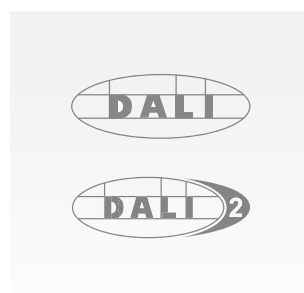

DALI / DALI 2 dimmable



3-Circuit selector inc. 0 for OFF



Adaptor locking lever

Surface Mounting Plate

For Surface Mounting on flat surfaces or a BESA box / Electrical components totally enclosed in fire proof enclosure.



Four way cable / conduit entry



Captive cover screws



Surface or BESA box mountable



Pendant Stem

Pendant Stem / Available in 300mm, 500mm or 1000mm lengths.

Casambi Switches

What is Casambi?

Casambi is a smart, wireless lighting control system that uses Bluetooth Low Energy (BLE) to allow you to control lights via an app, providing a flexible and scalable network for adjusting lighting and creating different ambiances. It builds a network where lights can communicate with each other and with a smartphone app or switch, allowing you to control them remotely.

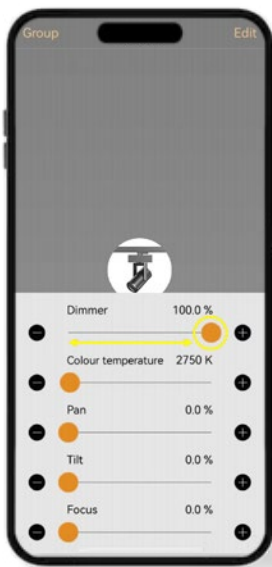

Casambi
Xpress
switch



Powered by
CASAMBI

Illuma's Casambi Xpress switch is a wireless user interface that can be configured via the Casambi app. The four preset buttons can control a scene, an animation of the user's choice, or simply one luminaire, one luminaire group or all luminaires together if so desired.

Xpress Features

Key features of the Casambi Xpress switch include:

- > Lumen output control
- > Change of colour temperature
- > Change of indirect/direct lighting ratio
- > Control individual or grouped luminaires
- > Recall scenes
- > Recall animations
- > Smooth dimming
- > Easy wireless Installation
- > Available in black or white

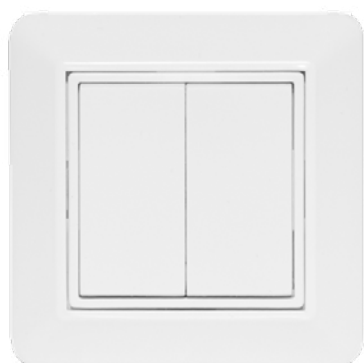
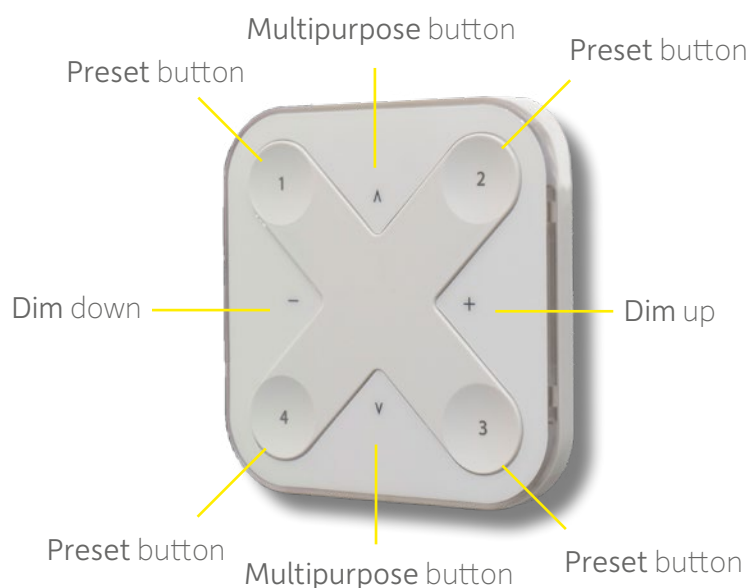

Casambi 4-button multi-function switch



Powered by
CASAMBI

Key features of the Casambi 4-button multi-function switch include:

- > Freely placeable (without cable)
- > Battery-free power supply
- > Individual configuration
- > ON/OFF switch
- > Smooth dimming
- > Control of all luminaires, groups and scenes
- > Change of color temperature
- > Resume / start automation

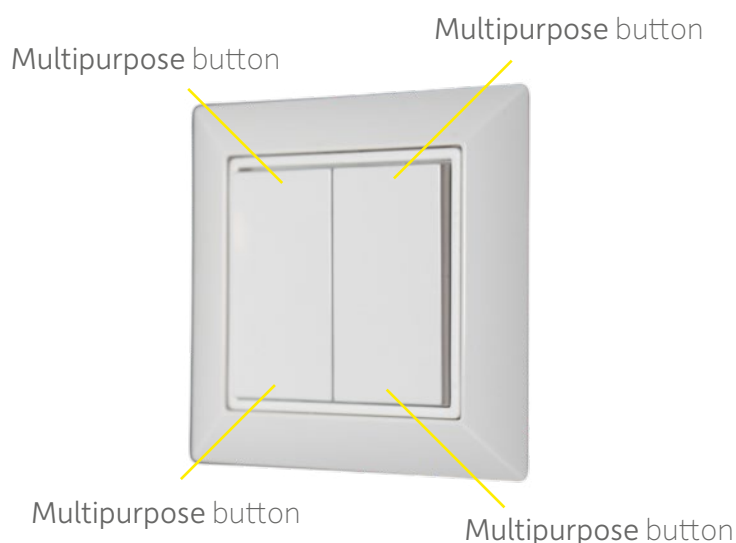

Spotlights

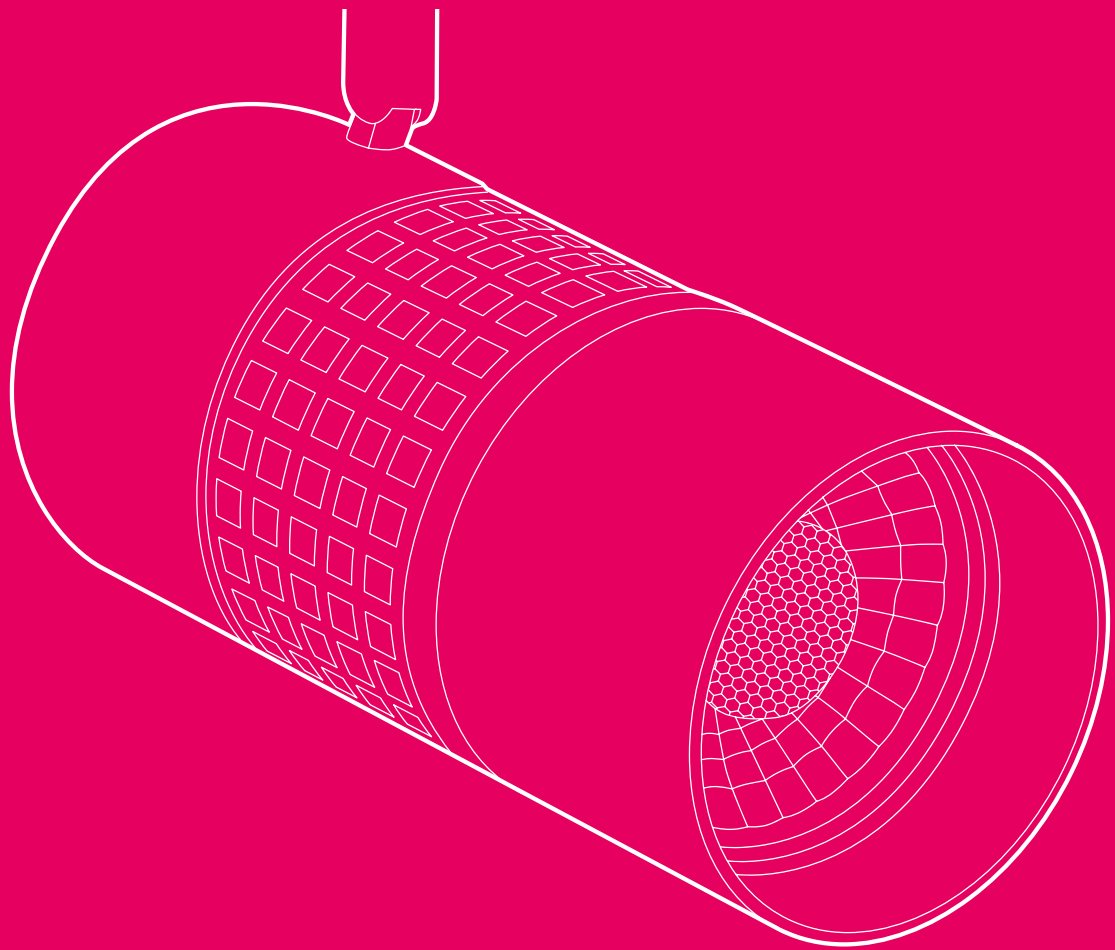

Accent lighting adds texture, focus and shape to general lighting by creating shadows and highlights for dramatic effects.

Spotlights

product range

A contemporary range of highly innovative spotlights, ideal for applications that require a flexible solution.



Torp

30



Concepta

32



Gridspot

34



Gridspot Anti-Glare

36



Chameleon

38



Probeam Select

40



Robospot

42



Probeam Frame

44



Probeam

46



Rotaspot

48



Lumapar

50



Lumapar GU10

52



Rocket E27

54



Topspot E27

56



Marktrack 24V

58

Torp



For further information, technical details and downloads scan the QR code or visit www.illumina.co.uk/torp

A sleek, cylindrical spotlight range available in five lumen outputs and a choice of four beam angles with a CRI of 98. Ideal for retail and display applications that require a high CRI and a clean look.

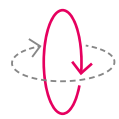

Vertical tilt 90°
Horizontal rotation 355°

Torp comes in a range of options to suit any installation:



Anti-glare option



Honeycomb louvre option



Advanced lens technology



Can be aimed vertically

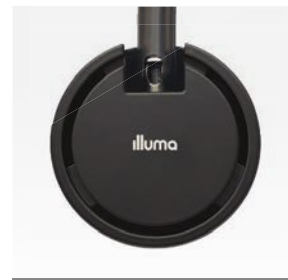

Discreet heat sink

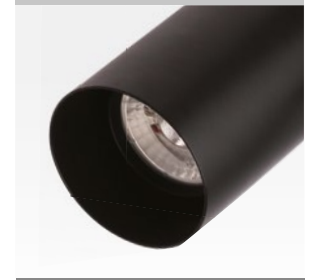

Standard option

Options available:

Lumen output

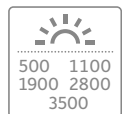

Colour temp.

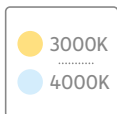

Body colour



Track mount



Style options

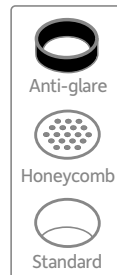

Beam angles

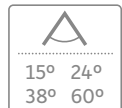

Body sizes



Surface mount



Vertical mount



Specification:

LED chip / CRI

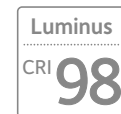

IP rating



Adjustable

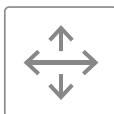

Anti-glare



Dimming options





Torp

Meridien Modena / Southampton, UK

Southampton based luxury car dealership with prestigious high-performance sports cars. Torp luminaires were specified to highlight the detail and beauty of these iconic motors utilising the 98CRI to bring out the best colour definition.

Concepta



For further information, technical details and downloads scan the QR code or visit www.illumina.co.uk/concepta

This versatile spotlight is Illuma's most energy efficient to date. Crafted from fully sustainable materials. The Concepta is a sleek, modern take on a classic, timeless Illuma design.



Concepta comes in a range of options to suit any installation:



White option



Black option



Advanced lens technology



Can be aimed vertically

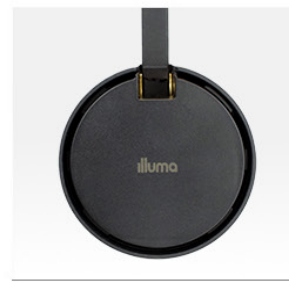

Discreet heat sink



Side profile

Options available:

Lumen output

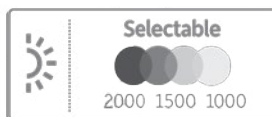

Lumen output

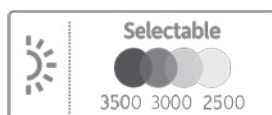

Colour temp.



Body colour



Track mount



Surface mount



Specification:

LED chip / CRI



IP rating



Adjustable

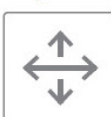

Anti-glare



Dimming options





Concepta

Elysian Living / London, UK

This London based luxury furniture store, chose Concepta to highlight their stylish interior. It's high CRI will emphasise the colours and textures in the woods and soft furnishings.

Gridspot



For further information, technical details and downloads scan the QR code or visit www.illumina.co.uk/gridspot

A range of distinct spotlights available in four lumen outputs and a choice of beam angles with a CRI of >80. Ideal for retail, leisure and display applications.



Gridspot is designed so that the heat sink forms part of the aesthetic:



Small black (1400lm)



Large white (≥2400lm)



Crisp and clean optic



Can be aimed vertically



Clean aesthetic

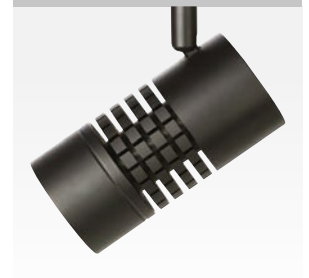

Black option

Options available:

Lumen output

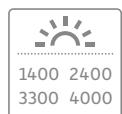

Colour temp.

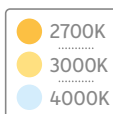

Body colour



Track mount



Beam angles



Body sizes



Surface mount



Vertical mount



Specification:

LED chip / CRI



Adjustable

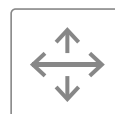

IP rating



Dimming





BODY FOCUS
FITNESS

Gridspot

Body Focus Fitness / Bristol, UK

The studio and lighting were designed to be functional, yet make clients feel at ease during their workout, providing them with a path to a healthy lifestyle.

Gridspot Anti-Glare



For further information, technical details and downloads scan the QR code or visit www.illumina.co.uk/gridspot-anti-glare

A flexible anti-glare range of distinct spotlights available in four lumen outputs and a choice of beam angles with a CRI of >80. Ideal for retail, leisure and display applications where glare could be an issue.



Vertical tilt 90°
Horizontal rotation 355°

Gridspot Anti-Glare is designed so that the heat sink forms part of the aesthetic:



Small black (1400lm)



Large white (≥2400lm)



Crisp and clean optic



Can be aimed vertically



Clean aesthetic



Exposed heat sink

Options available:

Lumen output

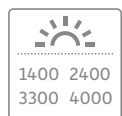

Colour temp.

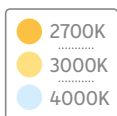

Body colour



Track mount



Beam angles



Body sizes



Surface mount



Vertical mount



Specification:

LED chip / CRI



Adjustable

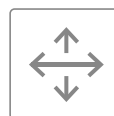

IP rating



Anti-glare



Dimming



Gridspot Anti-Glare

Canterbury Cathedral / Canterbury, Kent, UK

Often described as 'England in stone', the cathedral's rich history is intrinsically linked to the nation's story and is one of the oldest and most famous Christian structures in England. A World Heritage site.

Chameleon



For further information, technical details and downloads scan the QR code or visit www.illumina.co.uk/chameleon

A sleek cylindrical spotlight with cutting-edge AI technology, it possesses the ability to sense its environment and tailor the LED mix to enhance the colours it encounters by manipulating the light spectrum.

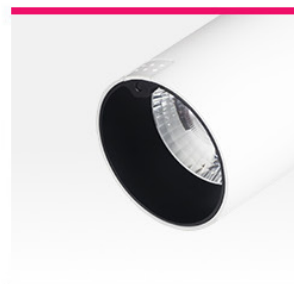

White option



Black option



Advanced AI technology



Can be aimed vertically



Discreet heat sink



Side profile

Options available:

Lumen output



Colour temp.

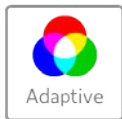

Body colour



Vertical mount



Beam angles



Body size



Track mount



Specification:

LED chip / CRI



Adjustable

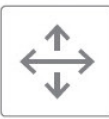

IP rating



Anti-glare





Chameleon

Liberty / London, UK

This historical London based luxury fashion brand chose the Chameleon to make the colours in their clothing ranges stand out.

Probeam Select



For further information, technical details and downloads scan the QR code or visit www.illumina.co.uk/probeam-select

Our tuneable spotlight available in five Kelvin temperatures (CCT) combined with a variable beam and a CRI of >90 provides post-installation flexibility. This range is ideal for galleries and museums.

Selectable colour temperature:

- 3000K
- 3500K
- 4000K
- 5000K
- 6000K

Adjustable beam
15 to 60°

Vertical tilt 90°
Horizontal rotation 355°

Probeam Select is perfect for highlighting defined areas:

White body

With Honeycomb accessory



Distinctive optic



Can be aimed vertically



Simple to use controls



Selectable CCT & self-dim

Options available:

<p>Lumen output</p> <p>2000</p>	<p>Colour temp.</p> <p>Selectable</p> <p>3000-6000K</p>	<p>Body colour</p> <div style="border: 1px solid black; padding: 2px; display: inline-block; margin-bottom: 2px;">White</div> <div style="background-color: black; color: white; padding: 2px; display: inline-block;">Black</div>	<p>Track mount</p>
<p>Beam angles</p> <p>15 to 60°</p>	<p>Body sizes</p> <p>1 size</p>	<p>Surface mount</p>	<p>Vertical mount</p>

Specification:

<p>LED chip / CRI</p> <p>CREE</p> <p>CRI >90</p>	<p>Adjustable</p>	<p>Anti-glare</p>	<p>Dimming</p> <p>Self dimmable</p>
<p>IP rating</p> <p>IP 20</p>	<p>Variable beam</p>	<p>Accessories</p> <p>Honeycomb</p>	



Probeam Select

Cris Contini Contemporary / Mayfair, London, UK

A modern and contemporary art gallery with global outreach, promoting world-renowned artists, located in the heart of London. It represents an unmissable point of reference for art lovers and collectors from around the world.

Robospot



For further information, technical details and downloads scan the QR code or visit www.illumina.co.uk/robospot

An innovative spotlight with built-in Bluetooth Casambi technology, which allows you to control all aspects including direction, beam angle, colour temperature and dimming all from the Casambi app.

Controlled with
CASAMBI

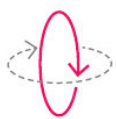

Vertical tilt 140°
Horizontal rotation 360°

Robospot comes in a range of options to suit any installation:

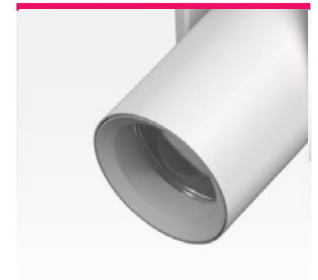

White option



Black option



Advanced lens technology



Can be aimed vertically



Discreet heat sink



Side profile

Options available:

Lumen output



1500

Colour temp.

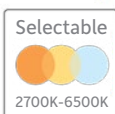

2700K-6500K

Body colour



White

Black

Track mount



Beam angles



18 to 60°

Body sizes



1 size

Surface mount



Specification:

LED chip / CRI



CRI > 95

Adjustable

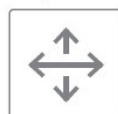

Variable beam

Dimming options



Casambi

IP rating



IP 20

Robospot

Velour Gallery / London, UK

This independent art gallery chose the Robospot to highlight their impressive art collection. Due to its Bluetooth controllability from the app the staff can create scenes without having to reach the product at high level.

Probeam Frame



For further information, technical details and downloads scan the QR code or visit www.illumina.co.uk/probeam-frame

Our framing spotlight enables the projection of geometric shapes with clear edges. A great solution for lighting works of art and highlighting specific areas. Perfect for changeable environments looking to highlight details.



Probeam Frame is perfect for highlighting defined areas:



White body



Adjustable optic



Can be aimed vertically



Clean aesthetic



Four point frame adjust

Options available:

Lumen output

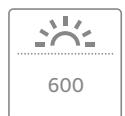

Colour temp.

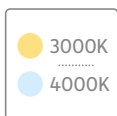

Body colour



Track mount



Beam angles



Body sizes



Surface mount



Vertical mount



Specification:

LED chip / CRI



Adjustable

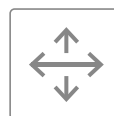

IP rating



Variable beam

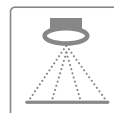

Dimming options



TATE EDIT

Art + objects for your home, chosen by TATE
All proceeds support TATE

Probeam Frame

Tate Edit Shop / Tate Modern, Bankside, London, UK

Tate Edit in London, is a unique space offering a carefully curated range of products to spark curiosity and inspire creativity.

Probeam



For further information, technical details and downloads scan the QR code or visit www.illumina.co.uk/probeam

This variable beam spotlight has been developed specifically for ever-changing applications such as art galleries, museums, retail environments and display applications.



Probeam provides accurate and effective beam control:



Black body



Adjustable beam (15 to 90°)



Adjustable optic



Can be aimed vertically



Clean aesthetic



Self-dim version

Options available:

Lumen output

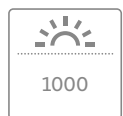

Colour temp.

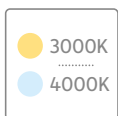

Body colour



Track mount



Beam angles



Body sizes

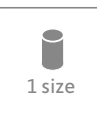

Surface mount



Vertical mount



Specification:

LED chip / CRI



Adjustable

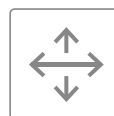

IP rating



Variable beam

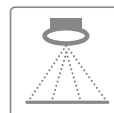

Dimming options





Probeam

Boo. / UK

Boo adds a modern twist on classic American burgers using only the finest fresh ingredients. Available multiple locations across the UK.

Rotaspot



For further information, technical details and downloads scan the QR code or visit www.illumina.co.uk/rotaspot

This contemporary award-winning spotlight has a 355° rotation both horizontally and vertically. An ideal solution for retail, leisure and commercial applications that require a bold lighting statement.



Rotaspot is a contemporary design in which the heat sink forms part of the aesthetic:



Black body



Integral heat sink



Philips LED chip



Award winning design



Unique circular profile



Back view of luminaire

Options available:

Lumen output

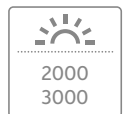

Colour temp.

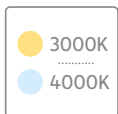

Body colour



Track mount



Beam angles



Body sizes



Surface mount



Vertical mount



Specification:

LED chip / CRI



Adjustable

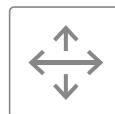

IP rating





Rotaspot

Other Criteria / London, UK

Founded by Damien Hirst, Other Criteria, London, collaborates with both established and emerging artists to make modern art approachable and attractive. With its technical performance alongside its aesthetic the white Rotaspot LED was deemed a perfect fit for the brand.

Lumapar



For further information, technical details and downloads scan the QR code or visit www.illumina.co.uk/lumapar

This compact and stylish range of versatile spotlights is available in two lumen outputs and a choice of beam angles, including a tight 6°. Ideal for retail, display and domestic applications that require highlighting and general lighting.



Lumapar is a small compact spotlight, ideal for low ceilings:



Black body



Silver Grey body



CREE LED chip



Can be aimed vertically



Rear heat sink as feature

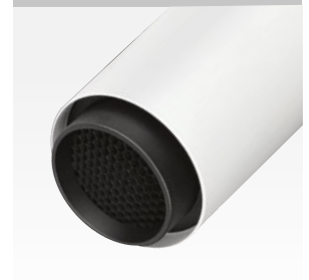

With honeycomb accessory

Options available:

Lumen output



Colour temp.

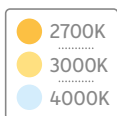

Body colour



Track mount



Surface mount



Vertical mount



Pendant stem

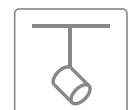

Specification:

LED chip / CRI



Adjustable

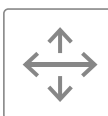

Dimming



Beam angles

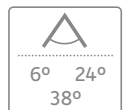

Body sizes



IP rating



Accessories

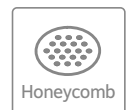



Lumapar

Monty's Bakehouse / Surrey, UK

Based in the beautiful Surrey countryside, it comprises a culinary development centre and offices, providing innovative and sustainably packaged food-to-go solutions for sporting venues, airports, universities and office canteens.

Lumapar GU10



For further information, technical details and downloads scan the QR code or visit www.illumina.co.uk/lumapar-gu10

A timeless range of versatile spotlights for GU10 LED and mains lamps not requiring a transformer. Ideal for retail, display and domestic applications that require highlighting and general lighting.

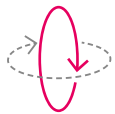

Vertical tilt 90°
Horizontal rotation 355°

Lumapar GU10 is a small spotlight. Choose between two different cowl lengths:



Black standard cowl



Silver Grey medium cowl



GU10 lamp not supplied



Can be aimed vertically

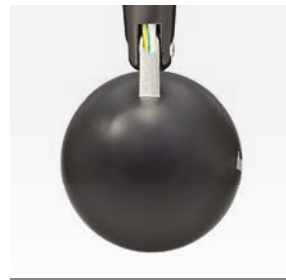

Bullet shaped rear



Polished chrome body

Options available:

Body colour



Retrofit lamps



Body sizes

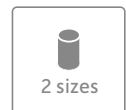

Track mount



Surface mount



Vertical mount



Pendant stem

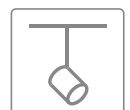

Specification:

Adjustable

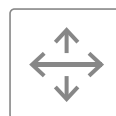

Anti-glare



IP rating



Accessories



Note: The long cowl is ONLY supplied as a stand-alone accessory.



Lumapar GU10

Central Bikes / London, UK

One of London's favourite retail stores for two-wheeled commuters, providing a great range of carefully selected scooters and motorbikes. A showroom and service centre that believes in simplicity and economy.

Rocket E27



For further information, technical details and downloads scan the QR code or visit www.illumina.co.uk/rocket-e27

A classic range of compact spotlights for mains operated, LED and PAR halogen lamps. Ideal for retail, display and domestic applications that require highlighting and general lighting.



Rocket E27 is ideal for retrofit lamps. Choose between three different cowl styles:



Black with standard cowl



White with standard cowl



E27 lamp not supplied



Can be aimed vertically



Shallow convex cone rear



Extended cowl option

Options available:

Body colour



Body sizes

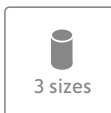

Retrofit lamps

E27

R60
R63
R80
PAR20
PAR30

Track mount



Vertical mount



Surface mount



Pendant stem

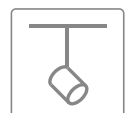

Style options



Specification:

Adjustable

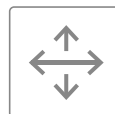

IP rating





Rocket E27

Cath Kidston / London, UK

Cath Kidston is a British international home furnishing retail company with headquarters in London, with a focus on handcraft and vintage themed items that embody a quintessentially British lifestyle.

Topspot E27



For further information, technical details and downloads scan the QR code or visit www.illumina.co.uk/topspot-e27

A versatile spotlight for LED, PAR halogen and mains reflector lamps. Ideal for retail, display and domestic applications that require general lighting or areas to be highlighted.



Topspot E27 is ideal for LED retrofit lamps of different types:



Rubber gasket for use with PAR20 lamps



E27 lamp not supplied



Can be aimed vertically



Vented back

Options available:

Body colour



Body sizes



Retrofit lamps

E27

R60
R63
R80
PAR20
PAR30
PAR38

Track mount



Surface mount



Vertical mount



Pendant stem

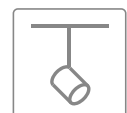

Specification:

Adjustable

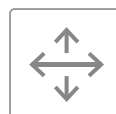

IP rating





Topspot E27

Brandy Melville / Covent Garden, UK

A contemporary clothing retailer representing classic Italian fashion elements, combined with vintage details. 'Made in Italy' stands for quality, where every detail is carefully examined.

Marktrack 24V



For further information, technical details and downloads scan the QR code or visit www.illumina.co.uk/marktrack-24v

A small and discreet 24V miniature LED spotlight and track system. This solution is ideal for retail, display and domestic applications requiring unobtrusive profiles with lower output bodies.

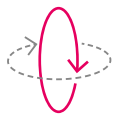

Vertical tilt 85°
Horizontal rotation 355°

Marktrack 24V

Two body sizes are available on this 24V miniature track system:



Black small body (550lm)



White large body (900lm)



CREE LED chip



Easy to fit and adjust



Clean and simple design



Surface driver option

Options available:

Lumen output



Colour temp.

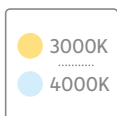

Body colour



Track mount



Beam angles

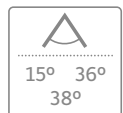

Body sizes



Vertical mount



Specification:

LED chip / CRI



Adjustable

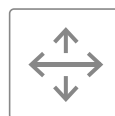

IP rating



Accessories

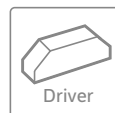

Track:

Marktrack lengths

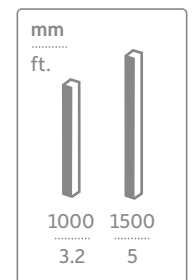

Sussex

Psychology

Marktrack 24V

The University of Brighton / Sussex, UK

A thriving, multi-campus University on the South Coast of England, its roots can be traced back to 1858. This modern site utilises our unobtrusive low-voltage system contributing to the critical importance of sustainability.

Marktrack 24V is an all-in-one compact track system that is easy to fit and adjust, ideal for display applications.



Discreet LED spotlight and track system with surface mounted driver - remote drivers are available

Linear

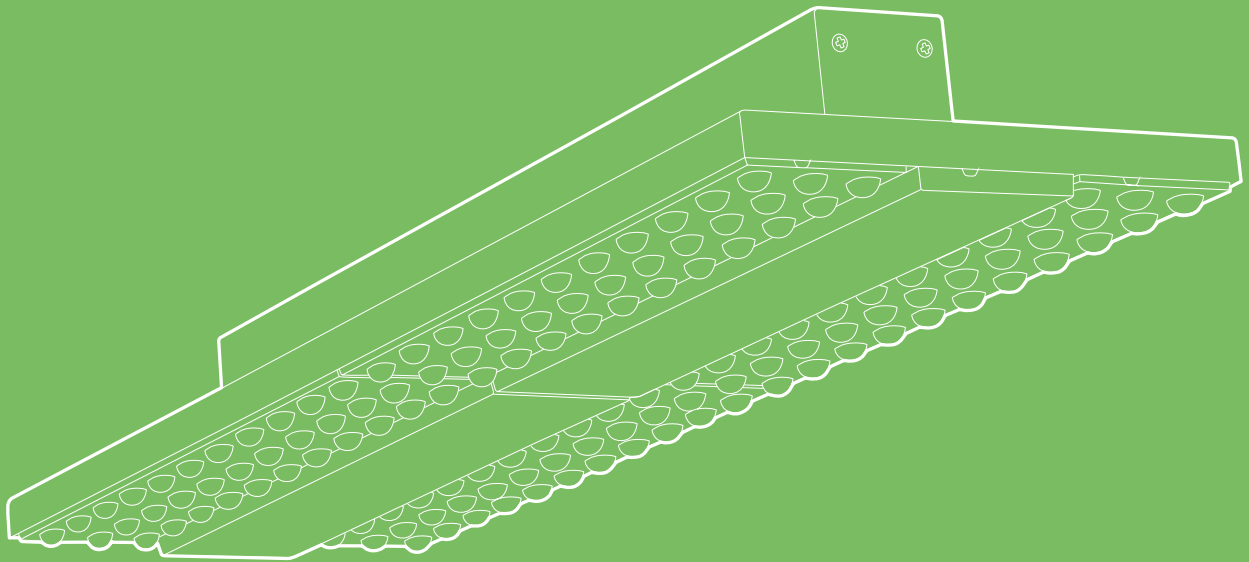

Linear lighting is ideal for uniform, open area lighting in multiple applications. Narrow and straight profiles are great for even vertical illumination or wallwashing.

Linear product range

A versatile range of linear lighting solutions that can dramatically transform the aesthetics and possibilities of how a space is illuminated.

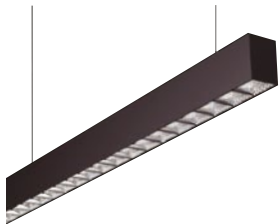

Linia Blade S 62



Linia Blade R 66



Linia Blade T 68



Floodline 70



Quadroled Linear 72



Quadroled 74



Revolva 76



Biline 78



Linia 80



Linkline 82

Introducing

Linia Blade S

Multiple styles. A sleek, suspended, surface or track mounted linear range that is available in a variety of options, including Continuous Row for our Suspended and Surface Mounted versions.

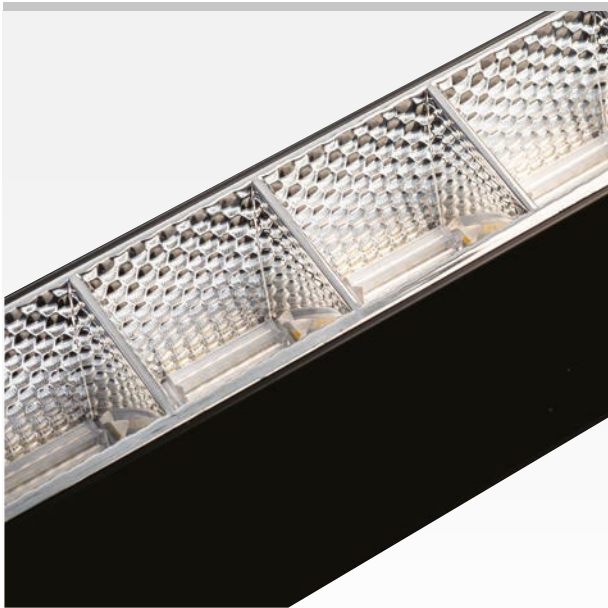

illumina /
products /
Linia Blade S

Indirect diffuser



Wallwash optic

Accessories

For **Suspended** and **Surface** versions:



Straight Connector



90° Connector



Pendant kit



End caps



T Connector



X Connector



Wire suspension



Blanking module

Bi-directional

Suspended /

- Direct
- Microprismatic
- Wallwash
- Opal Flood

Output 70% down / 30% up ratio

Direct

- Suspended
- Surface mounted
- Track mounted

The uplight (indirect) component provides a reflected, low glare distribution, whilst the downward component, available as either a Direct, Wallwash or Opal Flood optic, provides a general or direct level of illumination for the space below.

indirect diffuser
110° upward



Beam angle
Direct
85° x 85° downward



Direct
Designed to emit light directly downwards onto a surface, such as a desk or work area, where task lighting combined with a low glare output is required.

Microprismatic

- Suspended
- Surface mounted
- Track mounted



Beam angle
Microprismatic
85° downward



Microprismatic
Microprismatic lense has been designed to reduce the glare from the fitting, making this optic perfect for illuminating offices, classrooms and areas which require a lower Unified Glare Rating (UGR).

Wallwash

- Suspended
- Surface mounted
- Track mounted

When track mounted, the asymmetric outputs of the Wallwash versions are fixed to a right or left orientation.



Beam angle
Wallwash 55° x 85°
Left / Right



Wallwash
Wall washing illuminates a vertical surface with uniform brightness. Wall washing can draw attention to the wall and can make a room appear bright, providing a soft, diffused light into the space.

Opal Flood

- Suspended
- Surface mounted
- Track mounted



Beam angle
Opal Flood 110°



Opal Flood
Utilising an Opal Flood will provide a soft, seamless diffused low glare effect into the space.

Linia Blade S *continued*



For further information, technical details and downloads scan the QR code or visit www.illumina.co.uk/linia-blade-s

A sleek, versatile and contemporary linear range in a variety of suspended, track or surface mounted options. Ideal for applications requiring general or wallwash lighting. Suspended and surface variants can connect as continuous runs.

Polar curves

Direct Wallwash Opal Microprismatic

When track mounted, the asymmetric outputs of the Wallwash versions are fixed to a right or left orientation

Bi-directional version 110° upward

Bi-directional version 30% up / 70% down ratio

Beam angle
 Direct 85° x 85°
 Wallwash 55° x 90°
 Opal Flood 110°
 Microprismatic 85°

Linia Blade S comes in two lengths, each with two output options:

White Microprismatic option

Black Wallwash option

Black Opal Flood option

Glare reducing lenses

Joining connectors

Slim end profile (65mm x 47mm)

Options available:

Lumen output



Colour temp.



Body colour



Suspended



Surface mount



Style options

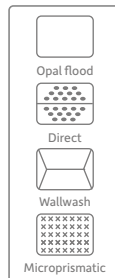

Specification:

LED chip / CRI

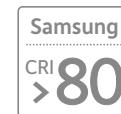

Dimming options



Beam angles



Body sizes

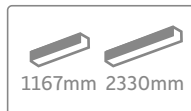

Track mount



Emergency



Accessories



Linia Blade S

The Museum of Making / Derby, UK

A contemporary space, telling Derby's 300-year-old history of making and inspiring new creativity. Featuring two beautiful areas for retail, the shop floor and hub - a dedicated space for makers.

Linia Blade R



For further information, technical details and downloads scan the QR code or visit www.illumina.co.uk/linia-blade-r

A sleek, recessed, linear range in three options with a choice of beam angles and lumen outputs. Ideal for applications that require discreet lighting as well as a direct light source to illuminate key features.

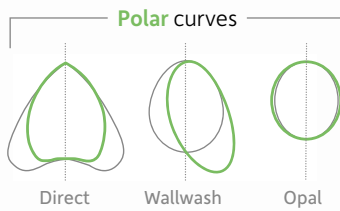

Beam angle
 Direct 85° x 85°
 Wallwash 55° x 90°
 Opal Flood 110°

Linia Blade R comes in two lengths, each with three styles:



Wallwash option



Opal Flood option



Direct profile



Wallwash profile



Opal Flood profile



Strong fixing clips

Options available:

Lumen output

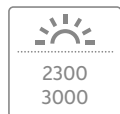

Colour temp.

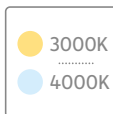

Body colour



Emergency



Style options



Specification:

LED chip / CRI



Wide beam



Dimming options



Beam angles

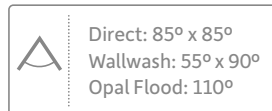

Body sizes

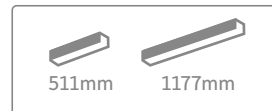

Cut-out

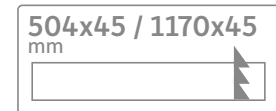



Linia Blade R

Marks & Spencer / London, UK

A major British multinational retailer with headquarters in Paddington, London, specialising in quality clothing, home, beauty and food products.

Linia Blade T



For further information, technical details and downloads scan the **QR code** or visit www.illumina.co.uk/linia-blade-t

A slimline, track mounted, linear range with a choice of three optics and two lumen outputs. Ideal for applications that require wall washing and general lighting.

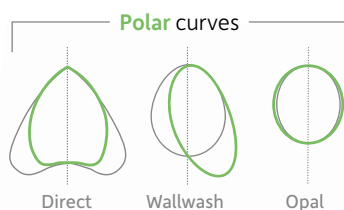

The asymmetric outputs of the Wallwash versions are fixed to a right or left orientation

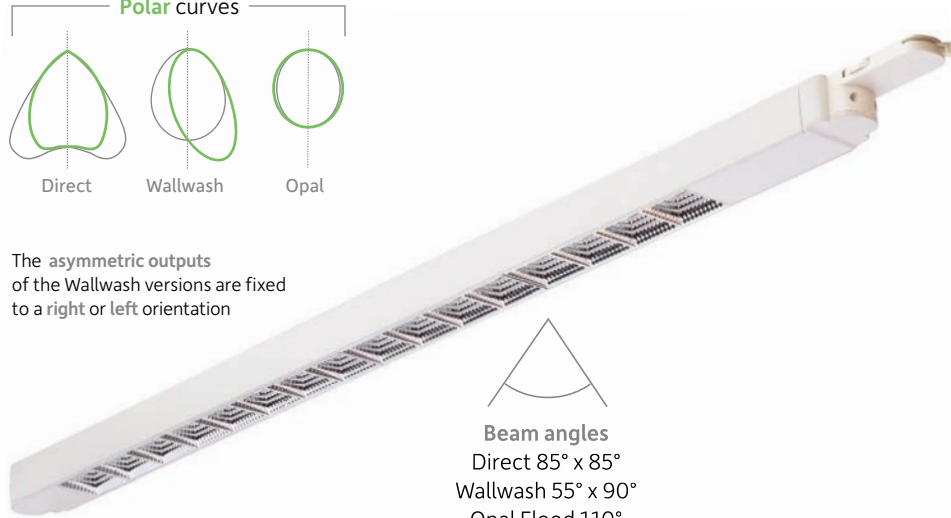

Beam angles
 Direct 85° x 85°
 Wallwash 55° x 90°
 Opal Flood 110°

Linia Blade T comes in two colours and three options:



Black Direct option



White Wallwash option



White Opal Flood option

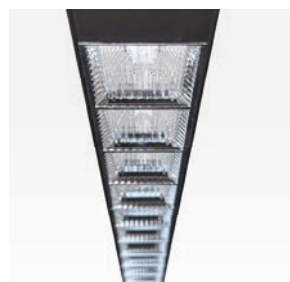

Direct profile



3-Circuit track adaptor



Wallwash profile

Options available:

Lumen output

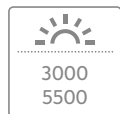

3000
5500

Colour temp.

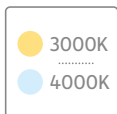

3000K
4000K

Body colour



White
Black

Track mount



Style options



Direct
Wallwash
Opal flood

Specification:

LED chip / CRI



Samsung
CRI > 80

Wide beam



Beam angles

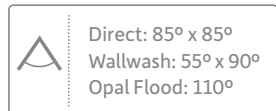

Direct: 85° x 85°
 Wallwash: 55° x 90°
 Opal Flood: 110°

Body size

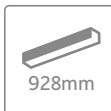

928mm

IP rating



IP
20

Linia Blade T

Process Gallery / Kent, UK

A working studio and sculpture garden, situated near Lenham, Kent contains the uniquely designed and landmark concrete chamber where owner and artist Nick Veasey creates his X-ray art.

Floodline



For further information, technical details and downloads scan the **QR code** or visit www.illumina.co.uk/floodline

This unique wall washer has been specifically developed with a compact profile, high lumen output, and a rectangular spread. It is ideal for providing even illumination of vertical surfaces and displays.

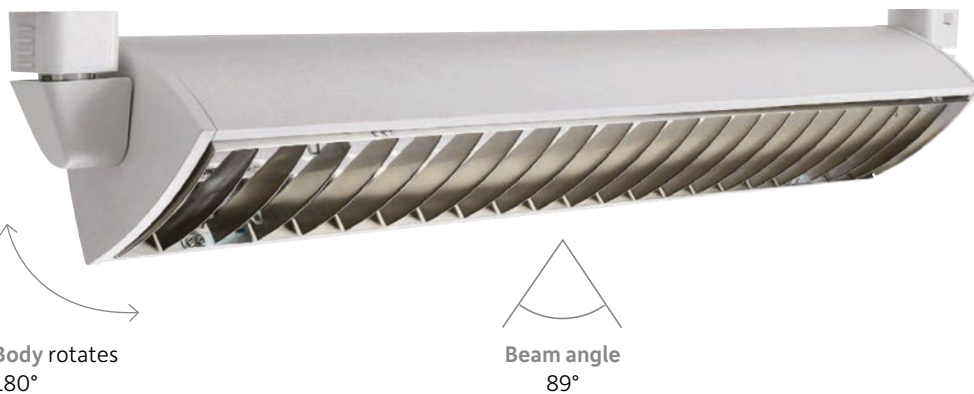

Quality stainless steel louvre for reduced glare & beam control



Curved profile



Stainless steel louvre

Options available:

Lumen output

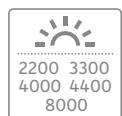

Colour temp.

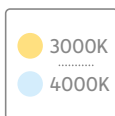

Body colour



Track mount



Surface mount



Beam angle



Body sizes



Vertical mount



Specification:

LED chip / CRI



Wide beam



Anti-glare



IP rating



Adjustable

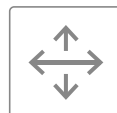

Dimming





Floodline

Sheppy's Cider / Somerset, UK

A stunning example of restaurant and retail lighting at its best. Sheppy's are one of the oldest premium craft cider making families in the world with a history that goes back more than 200 years.

Quadroled Linear



For further information, technical details and downloads scan the **QR code** or visit www.illumina.co.uk/quadroled-linear

A new statement piece providing a modern look. Ideal for the illumination of large areas that demand an efficient, powerful lighting system and allows configuration up to 9,300 lumens. An innovative optical lens system delivers an even distribution of light.

Selectable (600mm) lumen output:



Selectable (1500mm) lumen output:



Optical lens system



Mounts into 3-Circuit track



Black option



Four selectable lumen outputs

Options available:

Lumen output (600mm)

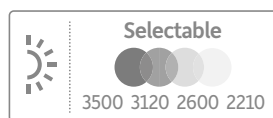

Lumen output (1500mm)

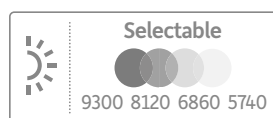

Colour temp.

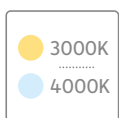

Body colour



Track mount



Specification:

LED chip / CRI



Wide beam



Dimming



Beam angle

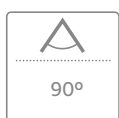

Body sizes

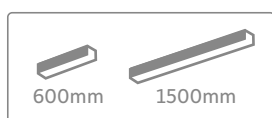

IP rating



Selectable output





Quadroled Linear

Alver Valley Garden Centre / Gosport, UK

Alver Valley Country Park and Garden Centre offers a great visitor experience for nature lovers, including a large coffee shop with panoramic views over the plant display areas and country park beyond.

Quadroled



For further information, technical details and downloads scan the **QR code** or visit www.illumina.co.uk/quadroled

Ideal for the illumination of large areas that demand an efficient, powerful lighting system that can be configured up to 11,500 lumens. An innovative optical lens system permits different beam angles onto a surface for a wide and even distribution of light.

Selectable lumen output:



Beam angles

Central component provides 2 x 90° for downward light
Outer component provides 4 x 25° for lighting the verticals



Low linear profile



Optical lens system



Four selectable lumen outputs

Options available:

Lumen output

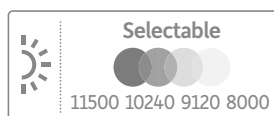

Colour temp.

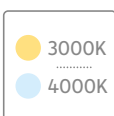

Body colour

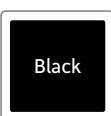

Beam angles

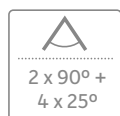

Body size



Track mount



Specification:

LED chip / CRI



Wide beam



IP rating



Selectable output



Quadroled

Polmar Foods Supermarket / London, UK

Their bright and spacious, modern new store in Wembley offers a wide variety of products from Eastern Europe.

Revolve



For further information, technical details and downloads scan the QR code or visit www.illumina.co.uk/revolve

An adjustable linear with a wide beam angle and high lumen output of 8,800 lumens. This range can be suspended as an accent light for extra drama and character, or track mounted. Diffusers rotate 150° for direct and indirect lighting effects.



3-Circuit track mount version

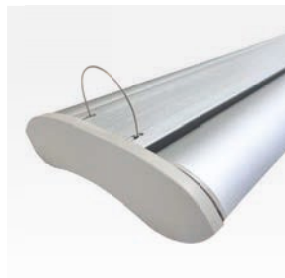

Curved aluminium profile



Rotated diffusers (down)



Rotated diffusers (up)

Options available:

Lumen output



Colour temp.

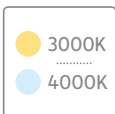

Body colour

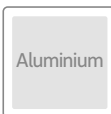

Track mount



Beam angle



Body size



Suspended



Specification:

LED chip / CRI



Wide beam



IP rating



Adjustable

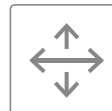

Dimming



Accessories



Revolva

Smart Office / Bankside, London, UK

A major new office complex development on Southwark Street. A creative and cultural neighbourhood set within one of the oldest areas of London.

Biline



For further information, technical details and downloads scan the QR code or visit www.illumina.co.uk/biline

A slim, surface mounted, or suspended linear solution which can connect to make continuous runs. Ideal for contemporary lighting applications that require general lighting and a direct light source.



Up to five can be joined in a continuous row (A+B+B+B+B)



Power connector



Biline end cap

Options available:

Lumen output



Colour temp.

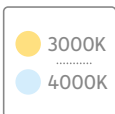

Body colour



Surface mount

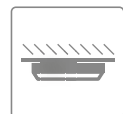

Beam angle



Body size



Suspended



Specification:

LED chip / CRI



Wide beam



IP rating



Joinable



Accessories





Biline

Sophia Contemporary Gallery / London, UK

A contemporary Gallery based in Mayfair which showcases and promotes unique art by emerging and established artists.

Linia



For further information, technical details and downloads scan the **QR code** or visit www.illumina.co.uk/linia

An unobtrusive recessed, linear solution with a wide beam angle and high output of 8,800 lumens. This range is ideal for applications that require discreet lighting as well as a direct light source to illuminate key features.

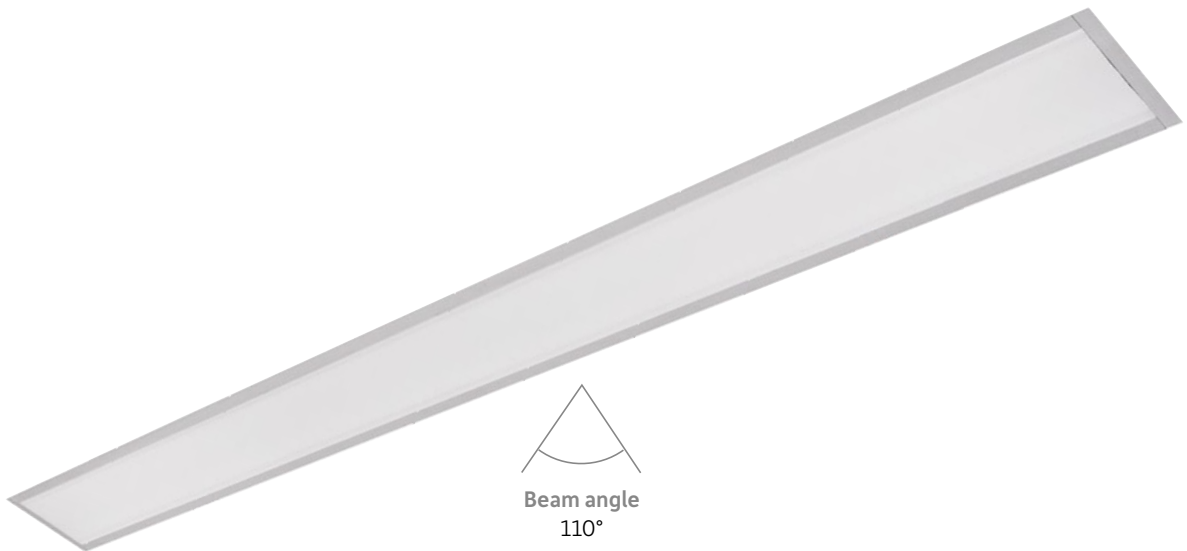

Robust aluminium body



Recessed profile



Minimal aluminium frame



Strong fixing clips

Options available:

Lumen output

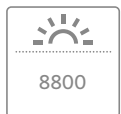

8800

Colour temp.

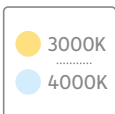

3000K
4000K

Body colour

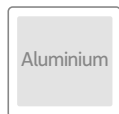

Aluminium

Beam angle



110°

Body size



1200mm

Specification:

LED chip / CRI



Vossloh
CRI
>80

IP rating



IP
20

Wide beam



Recessed



Cut-out



1190x85
mm

Dimming



DALI 2



Linia

Palamon Court / Canterbury, UK

Bespoke accommodation offering a range of studio and en-suite student rooms located in the heart of the city.

Linkline



For further information, technical details and downloads scan the **QR code** or visit www.illumina.co.uk/linkline

A linkable system which connects to make continuous runs. Can be installed in straight runs or curves. Ideal for feature cove and under cabinet lighting in multiple interiors.

**Easy
plug+play
system**

Each individual unit is independently switchable

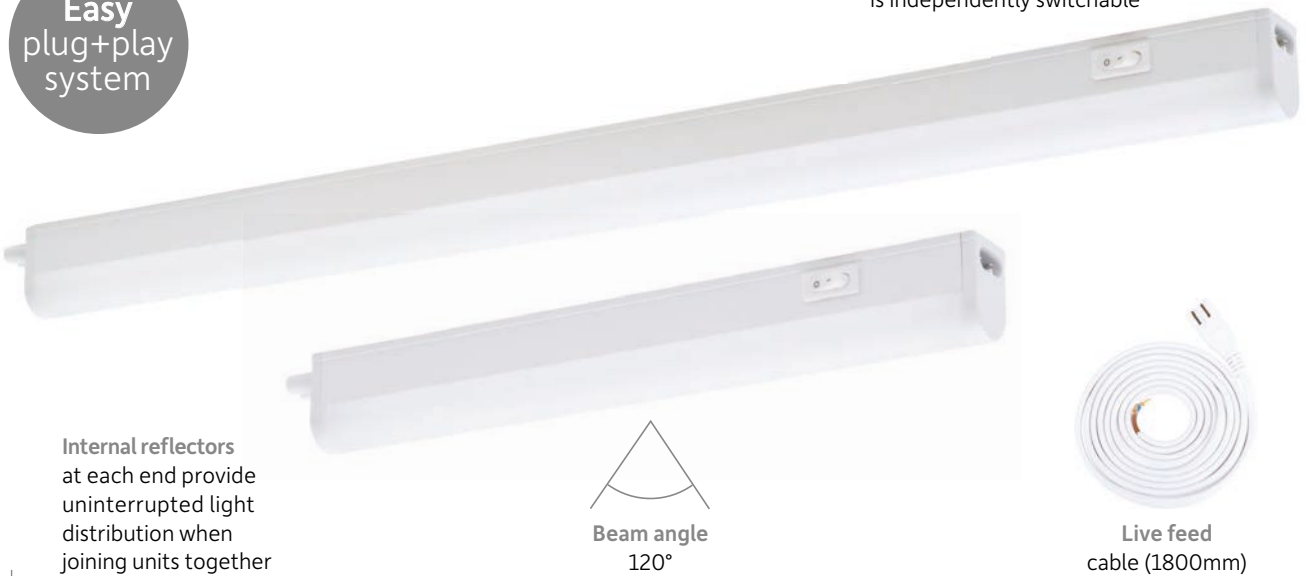

Flexible connection cable (150mm) available



Each fitting can be connected to the next to form a continuous row

Options available:

Lumen output	Colour temp.	Body colour	Surface mount
 300 720 1050 1550 1800	 3000K 4000K	 White	
Beam angle	Body sizes	Vertical mount	
 120°	 5 sizes		

Specification:

LED chip / CRI	Wide beam	Body size / Lumen options
 CRI >80		
IP rating	Joinable	
 IP 20		Length (mm) Lumens
		 289 550 850 1150 1450 300 720 1050 1550 1800



Linkline

David Mellor / Marylebone, UK

Located just off Marylebone High Street, their biggest shop to date showcases the full David Mellor collection of tableware and kitchenware, with a special emphasis on domestic British craft products.

Track systems

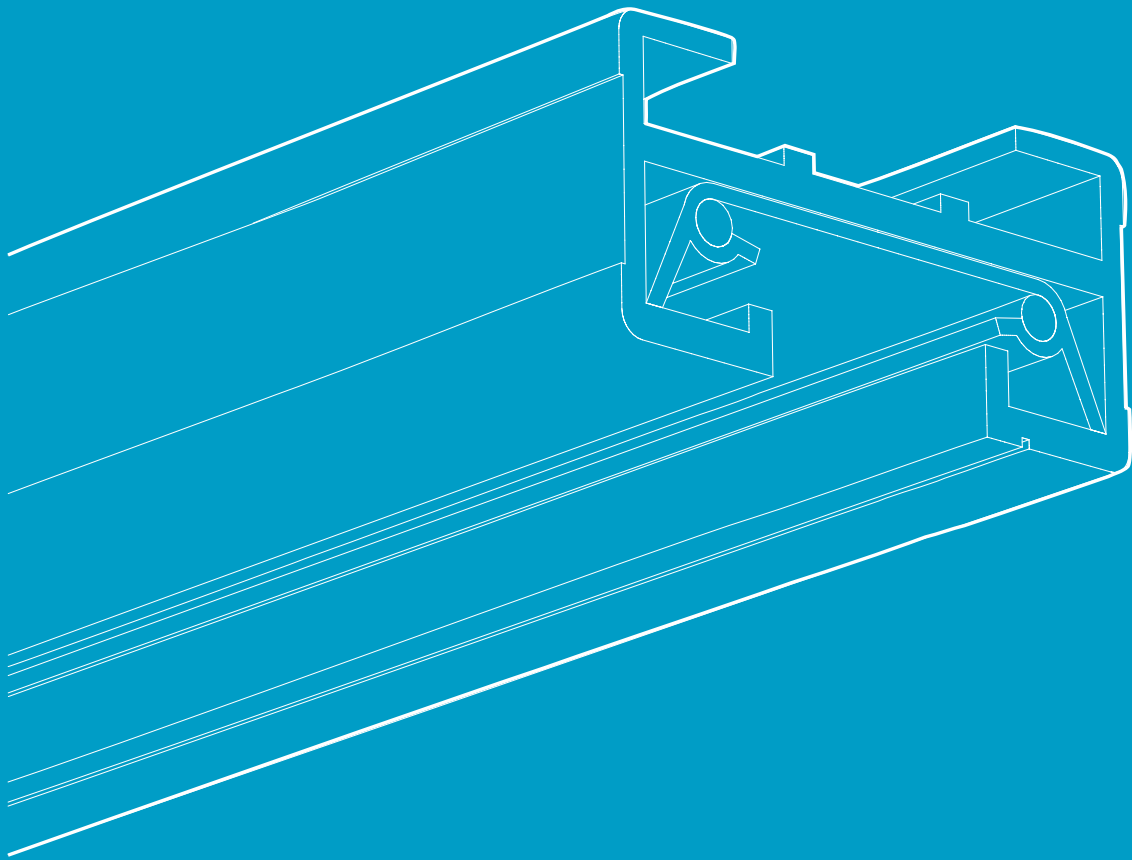

Track systems are the most versatile lighting tool for galleries, exhibitions, retail and other display applications. Allowing luminaires to be positioned precisely where required.

Track systems product range

A comprehensive range of mains track systems that provide an easy to install, future proof and flexible solution to any interior environment.



CLEVR 230V

88



1-Circuit Track 230V

90



3-Circuit Track 230V

92



3-Circuit
Track 230V Recessed

92



Control Track 230V

94



Control Track
Track 230V Recessed

94

Introducing Track

Multiple styles.

A comprehensive range of mains track systems providing versatility for all applications.

Flexible

Track is easy to cut and join.

Future proof

Luminaires can be added or removed easily.

Quick to install

With just one **power feed** and a variety of connectors available, track can be quickly installed.



illuma /
products /
track systems

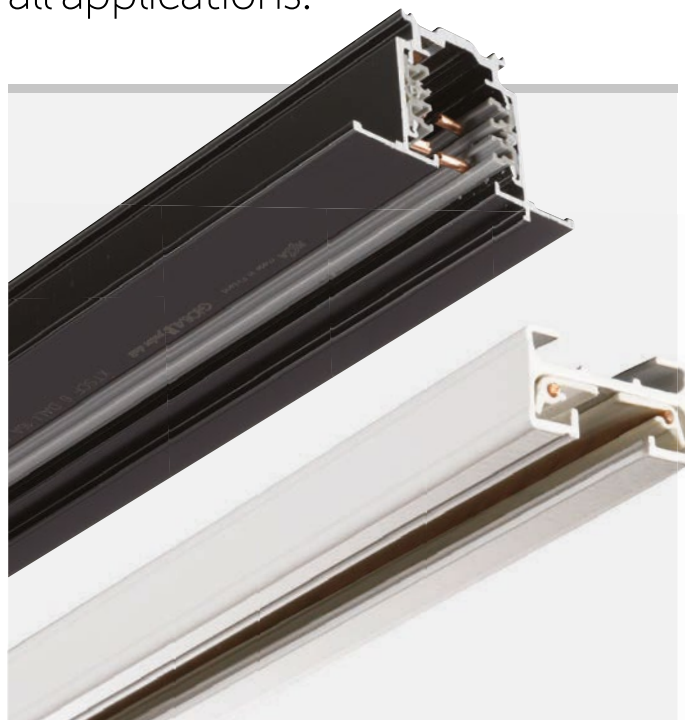

Installation options:

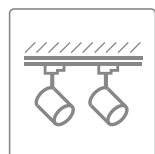

Surface



1-Circuit



3-Circuit



Control Track

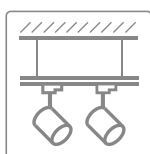

Suspended



1-Circuit



3-Circuit



Control Track

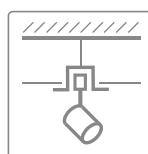

Recessed

Note: Recessed Track needs to be fixed to a solid surface with the suspended ceiling built around it.



3-Circuit Recessed



Control Track Recessed

Track types:

1-Circuit Track

1-Circuit track system / powers all luminaires attached to the track on one circuit only. The power to the track can be controlled by a switch or a dimming module.

illumina /
track /
1-circuit



3-Circuit Track

3-Circuit track system / is a type of lighting track that has three separate circuits, each of which can be independently controlled to provide power and control to different groups of luminaires. The power to each circuit can be controlled by a switch or a dimming module.

illumina /
track /
3-circuit



Recessed Track

Recessed track system / has the same benefits as the 3-Circuit Track but is recessed into the ceiling which provides a clean, unobtrusive look. Ideal when a minimalistic architectural aesthetic is required.

illumina /
track /
recessed



Control Track

Control track system / contains a pair of control wires to pass the digital signal to DALI dimmable luminaires. Control Track can be surface mounted and suspended. It is also available as recessed.

illumina /
track /
control



CLEVR



For further information, technical details and downloads scan the QR code or visit www.illumina.co.uk/clevr

The Casambi-Live-End-Versatile-Radio is designed to make any leading and trailing edge compatible track luminaires easily dimmable, with its Bluetooth capability.

Controlled with
CASAMBI



CLEVR comes in a white or black finish:



White Finish



Black Finish



Sleek 3D printed design

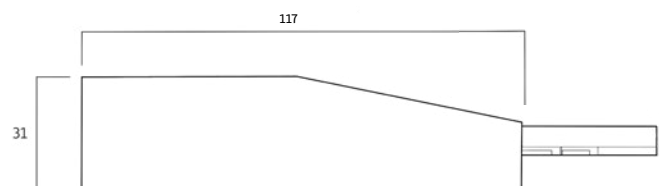

Options available:

Body colour



Suspended



Surface mount



Vertical mount



Specification:

Max Wattage



Live end

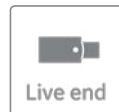

IP rating



Dimming options



Casambi-Live-End-Versatile-Radio



Control up to 100 Watts
Example:
11.2W Lumapar Spotlights
(100W/11.2W) = 8 per CLEVR



- Control track lighting via phone or tablet
- Cost effective 'Plug & Play' solution
- Enjoy benefits of ON/OFF/DIM/SAVE SCENE

Controlled with
CASAMBI

Attaching CLEVR to track (1-Circuit)

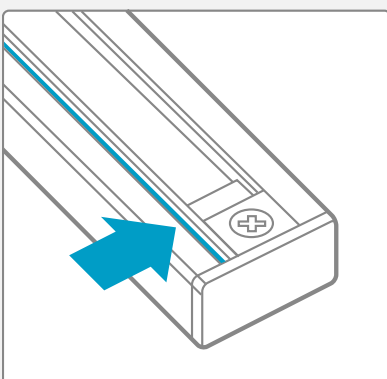

A **groove** runs along the edge of the track to show the LIVE.

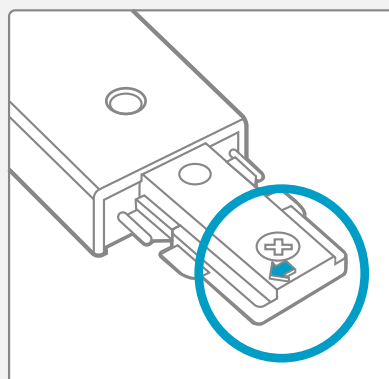

Every adaptor and accessory has an **arrow** moulded on it.

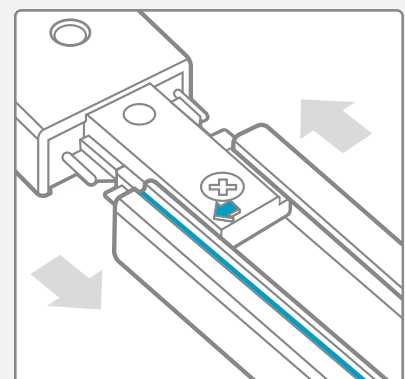

The **arrow** must point at the **groove** when joining track

NB: CLEVR is for use with Illuma's 1-Circuit 230V track only

1-Circuit Track 230V



For further information, technical details and downloads scan the QR code or visit www.illumina.co.uk/1-circuit-track-230v

16A Mains voltage track, connector and accessory system. Ideal for applications where spotlights may need to be frequently added or removed.



Suspension wires



1-Circuit Track 230V

comes in a variety of colours and lengths:

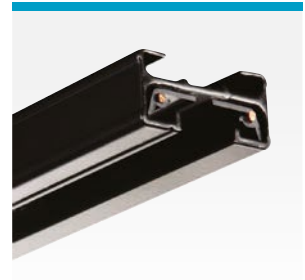

Black finish



Silver Grey finish

Options available:

Track sizes

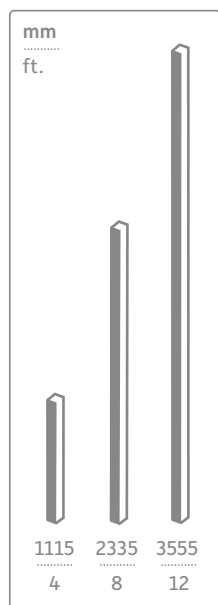

Body colour



Track connectors

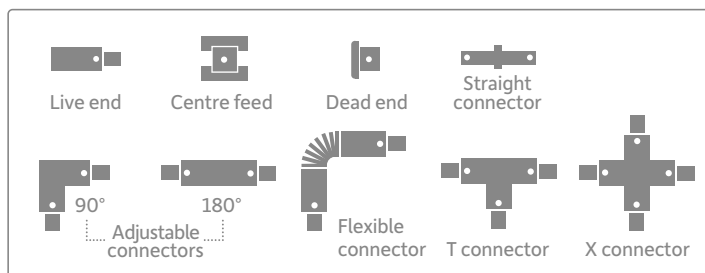

Specification:

1-Circuit

230V
16A

IP rating

IP
20

Surface mount

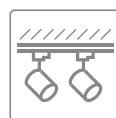

Joinable



Suspended

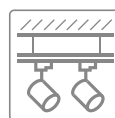

Accessories

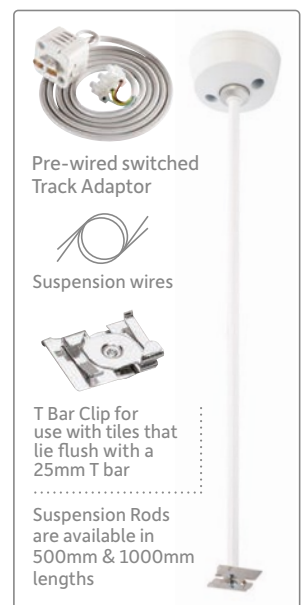

1-Circuit Track system

Planning a layout

Track layouts can be designed to provide a solution for most environments. If you require any help in working out your layout, please contact us.

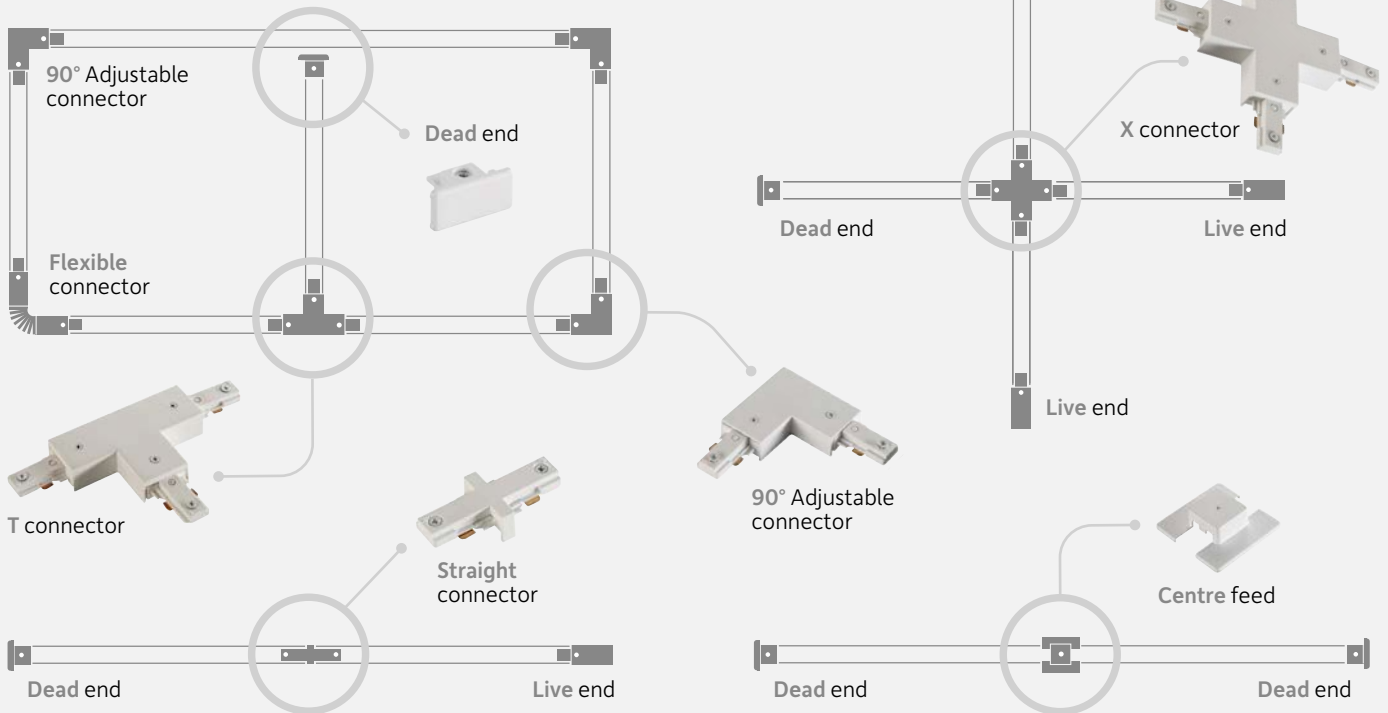

Track polarity (1-Circuit)

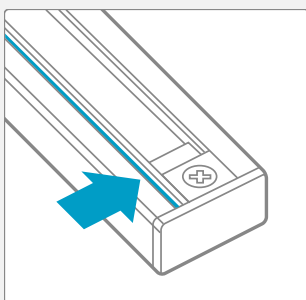

A **groove** runs along the edge of the track to show the LIVE.

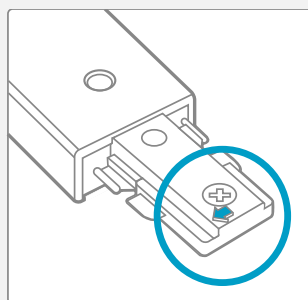

Every adaptor and accessory has an **arrow** moulded on it.

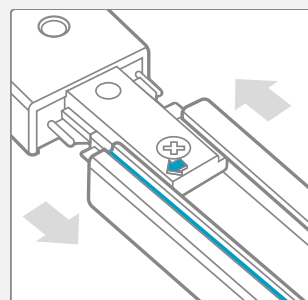

The **arrow** must point at the **groove** when joining track

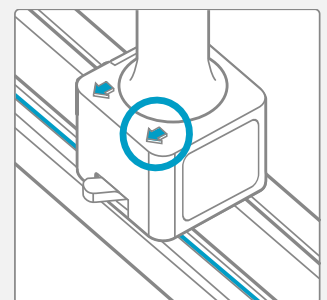

Track Adaptor must also point to the LIVE groove.



illumina /
how to /
cut track



illumina /
how to /
attach luminaire



illumina /
how to use /
suspension wire

3-Circuit Track 230V



For further information, technical details and downloads scan the QR code or visit www.illumina.co.uk/3-circuit-track-230v

16A Mains voltage track system. Enabling up to three lighting configurations to be set up on one track - controlled and switched individually.



Why recessed?
See p87



Suspension wires

3-Circuit Track 230V comes in a variety of colours and lengths:



Black finish



Silver Grey finish (recessed)



Bending tool

Options available:

Track sizes

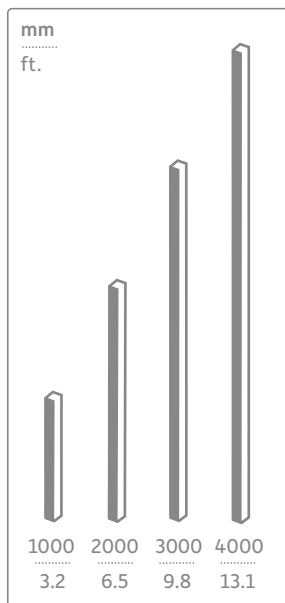

Body colour



Specification:

3-Circuit

230V
16A

IP rating

IP
20

Surface mount



Joinable



Suspended

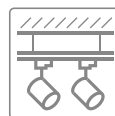

Recessed



Accessories



Track connectors

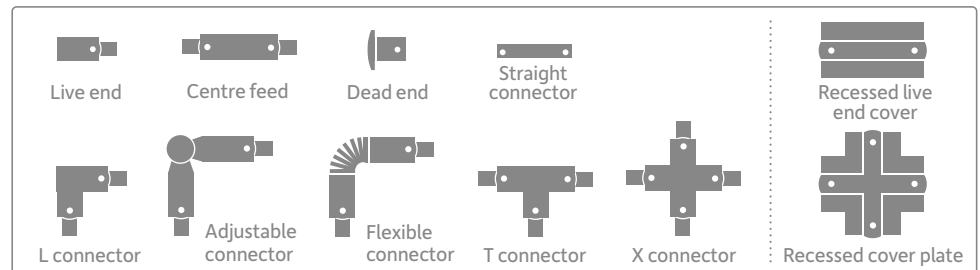

3-Circuit Track system

Planning a layout

When planning a layout with 3-Circuit 230V track the **blue line** indicates the neutral polarity ridge on the track.

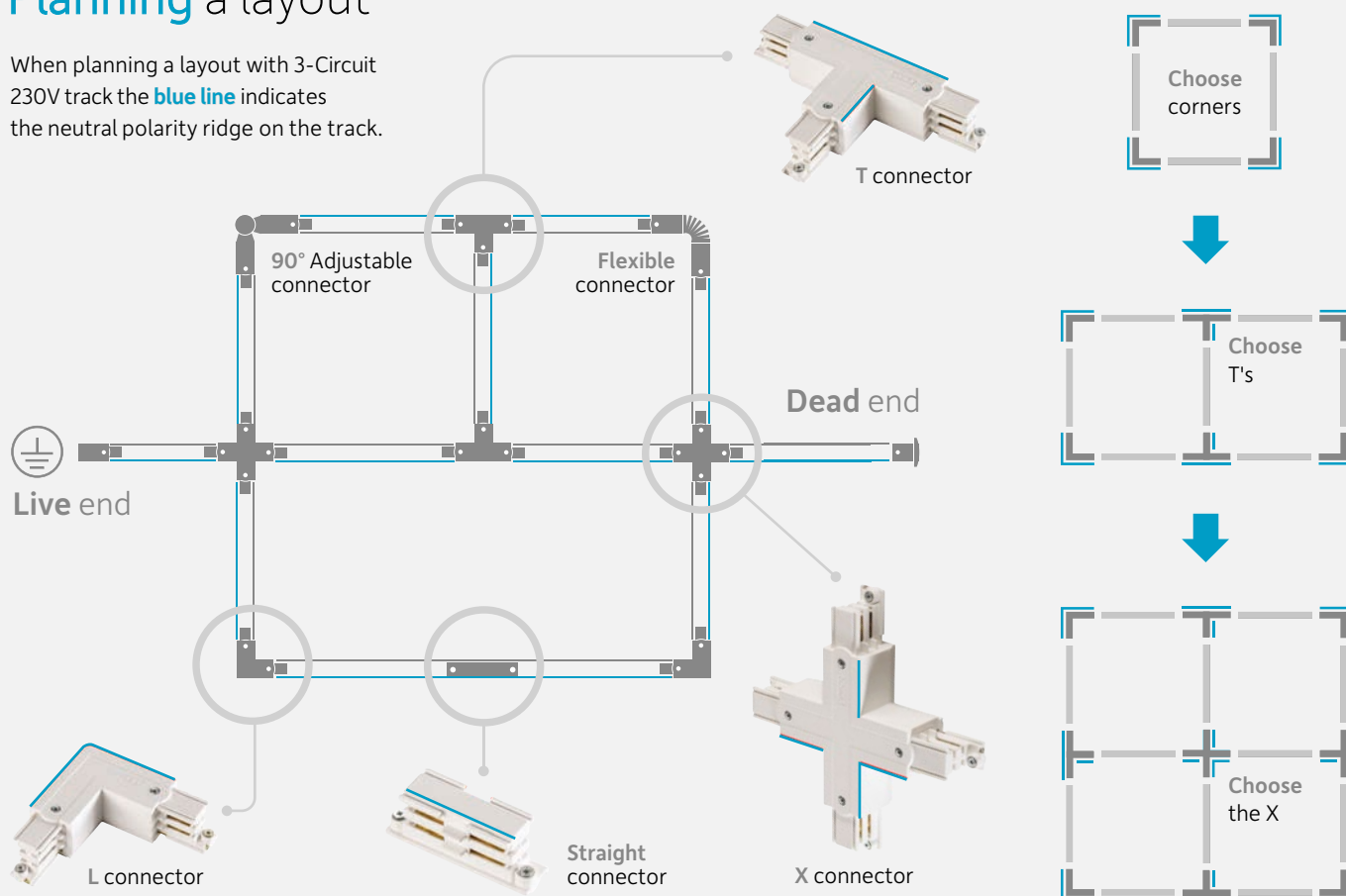

How the system works (3-Circuit)

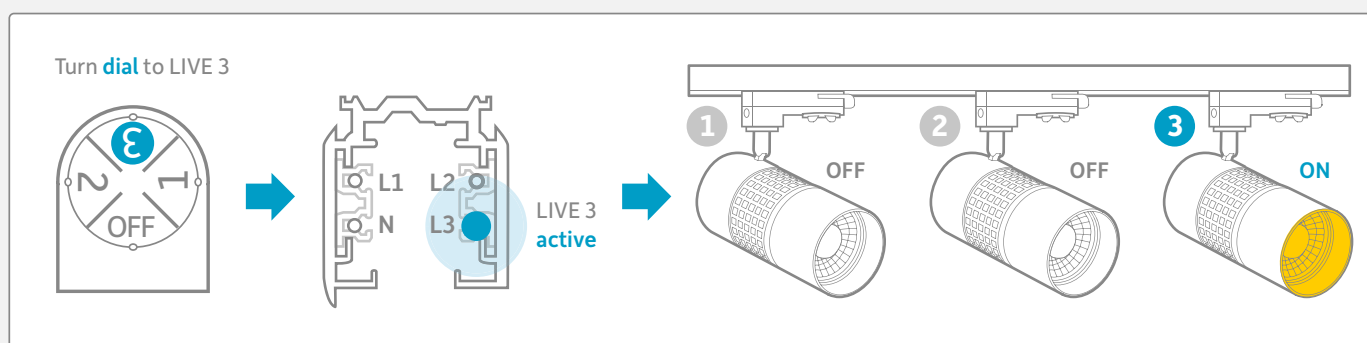

illumina /
how to /
cut track



illumina /
how to /
attach luminaire



illumina /
how to use /
suspension wire

Control Track 230V



For further information, technical details and downloads scan the QR code or visit www.illumina.co.uk/control-track-230v

16A Mains voltage track system that has all the benefits of 3-Circuit track but with the additional ability to communicate the digital signal for DALI enabled luminaires.



Control Track 230V comes in a variety of colours and lengths:



Black finish



Silver Grey finish (recessed)



Bending tool

Options available:

Track sizes

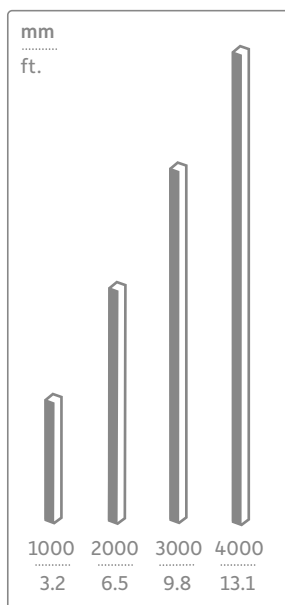

Body colour



Specification:

3-Circuit

230V
16A

IP rating

IP
20

Surface mount



Joinable



Suspended

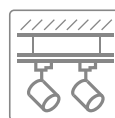

Recessed

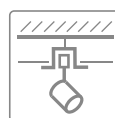

Accessories



Track connectors

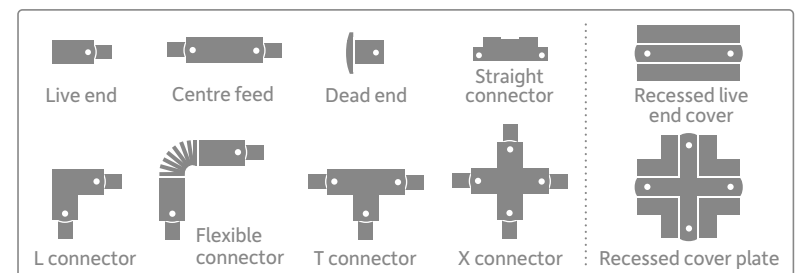

Why recessed?

Provides a sleek and modern lighting solution for interior spaces /

Ideal for galleries, museums or any modern interior. Installed into a ceiling or wall, they provide a clean and streamlined look. Available in 3-Circuit and Control Track versions, recessed tracks are a popular choice for those looking for a modern and functional lighting solution that is both versatile and efficient. Please be aware that recessed track needs to be hung from a solid surface with the suspended ceiling built around it.



Why suspended?

Suspended tracks are used to provide a versatile and flexible lighting solution /

Suspension wires are installed onto the ceiling and the track is hung to the desired level within the space. Suspending track is a great option for spaces with high ceilings, as they allow for lighting to be brought closer to the task area, creating a more intimate and comfortable atmosphere. Our 1-Circuit, 3-Circuit and Control Tracks can be suspended.

What is DALI?

Control Track has a pair of control wires within the track which facilitates the communication of a digital signal to individual DALI (Digital Addressable Lighting Interface) compatible luminaires /



It can be useful in a variety of settings, from retail stores to art galleries through the creation of different lighting scenes and the ability to adjust lighting levels in response to changes in ambient lighting conditions.

Control Track is designed to be flexible and scalable, so it can be used in a wide range of settings, from small installations to large-scale projects. It also supports the integration of other lighting control systems such as emergency lighting to provide a comprehensive solution.

How the system works (Control Track)

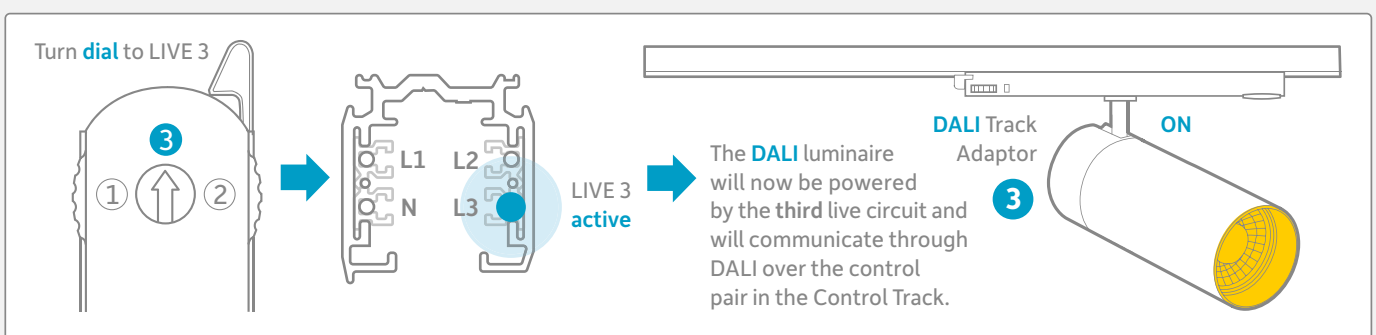

Project downlights

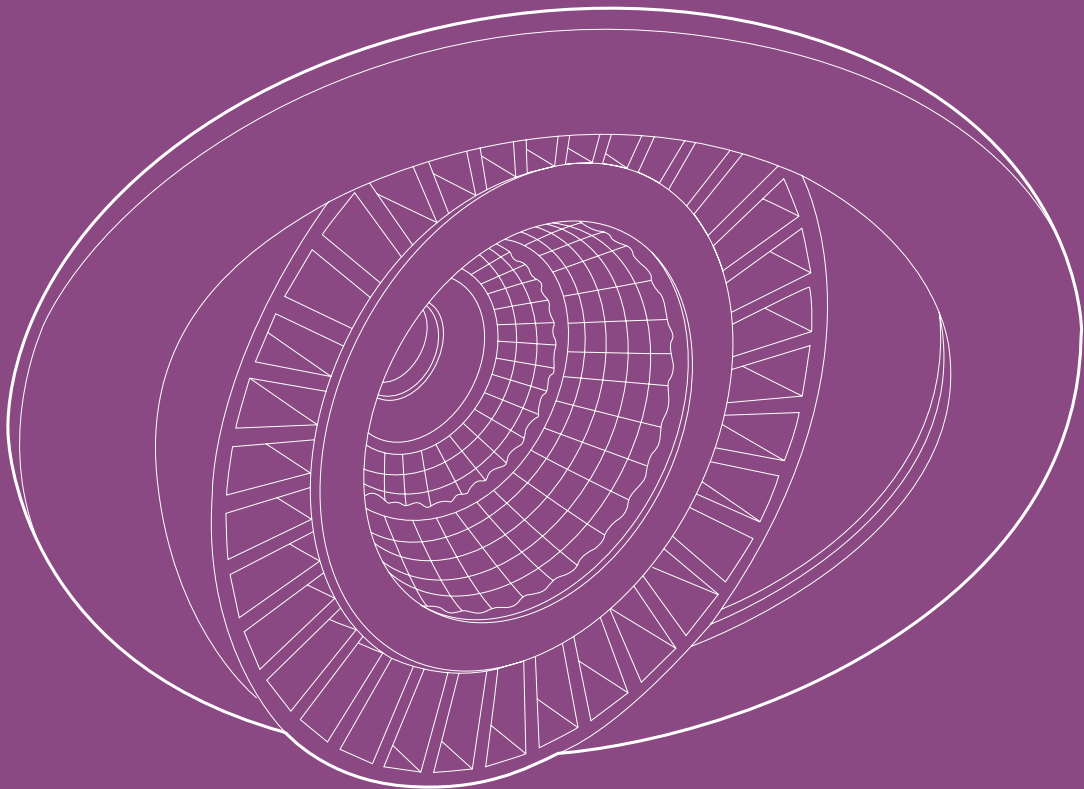

Project downlights are popular for various settings like retail, leisure, cafes, and residential properties. They are versatile and cost-effective, enhancing any space's ambience, creating a warm or bright environment.

Project downlights product range

06

An extensive range of highly innovative project downlights, suitable for multiple environments.



Twizzle

98



Project 90 Open

100



Project 90 Cone

102



Project 90 Gimbal

104



Project 90 Wallwash

106



Framelight Mini

108



Proseal F

110



Project 50

112



Firehoods

114

Twizzle



For further information, technical details and downloads scan the QR code or visit www.illumina.co.uk/twizzle

This modern downlight range has a fully adjustable body that rotates 355° and pivots ±90°. Specifically for environments that require a flexible downlighting solution, such as: retail, car showrooms, hotels and display applications.



Head rotates 355° /
Pivots ±90°

Twizzle, a unique design with surprising tilt feature and shallow profile:



Black body



As a recessed uplighter



Fire Hoods



Crisp and clean optic



Integral heat sink



Head in flush position



Head positioned at 90°

Options available:

Lumen output

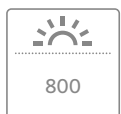

800

Colour temp.

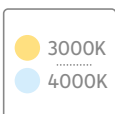

3000K
4000K

Bezel colour



White
Black

Beam angles



24° 40°

Bezel sizes

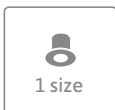

1 size

Specification:

LED chip / CRI



CREE
CRI > 80

Recessed



Cut-out Ø

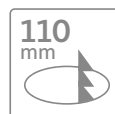

110 mm

IP rating



IP 20

Adjustable

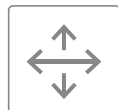

Driver



Included

Dimming options



Casambi

Leading & trailing edge

Twizzle

Sheppy's Cider / Somerset, UK

With a cider-making legacy that dates back over two centuries, Sheppy's is a family-run enterprise. Their Taunton location showcases a remarkable application of lighting that serves as a prime example of exceptional restaurant and retail lighting.

Project 90 Open



For further information, technical details and downloads scan the **QR code** or visit www.illumina.co.uk/project-90-open

A classic downlight available in a choice of beam angles and lumen outputs, for multiple interior applications and general lighting. Dimmable and emergency versions available.



Project 90 Open is available in three LED colours, including 2700K Extra Warm White:



Black bezel



Easy twist & lock connector between downlighter & driver



Robust fixing clips



Fire Hoods



IP44 - Bathroom zones 2 & 3



925lm LED light engine



625lm LED light engine

Options available:

Lumen output



Colour temp.

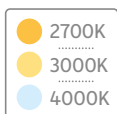

Bezel colour



Beam angles



Bezel sizes



Emergency



Specification:

LED chip / CRI



Recessed



Cut-out Ø

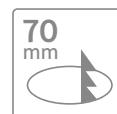

IP rating



Driver



Dimming options





Project 90 Open

Crown Diamond Jewellers / Brighton, UK

A bespoke high-end jeweller situated in the historic Lanes of Brighton.
Beautiful designs with a passion to create stunning accessories.

Project 90 Cone



For further information, technical details and downloads scan the **QR code** or visit www.illumina.co.uk/project-90-cone

A stylish downlight available in a choice of beam angles, lumen outputs and three cone colour options. Ideal for both highlighting and general lighting in multiple interior applications. Dimmable and emergency versions available.

Project 90 Cone comes in two body colours and three cone colour options:



LED Light Engine (only) pivots $\pm 60^\circ$



Fire Hoods



White bezel with Black cone



White bezel with Silver cone



White bezel with White cone



Crisp and clean optic



925lm LED light engine



625lm LED light engine

Options available:

Lumen output



Beam angles

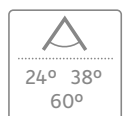

Colour temp.

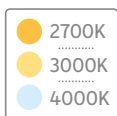

Bezel sizes



Bezel colour



Emergency



Cone options



Specification:

LED chip / CRI



IP rating



Recessed



Anti-glare



Cut-out Ø



Driver



Dimming options





Project 90 Cone

Southampton University / London, UK

A perfect example of effective lighting design, utilising our Project 90 range to enhance this modern space.

Project 90 Gimbal



For further information, technical details and downloads scan the QR code or visit www.illumina.co.uk/project-90-gimbal

A versatile gimbal downlight available in a choice of beam angles and lumen outputs. Ideal for both highlighting and general lighting in multiple interior applications. Dimmable and emergency versions available.



Light Engine combined with inner bezel pivots $\pm 45^\circ$



Fire Hoods

Project 90 Gimbal is available in three LED colours, including 2700K Extra Warm White:



Black bezel



Easy twist & lock connector between downlighter & driver



Crisp and clean optic



925lm LED light engine



625lm LED light engine



Robust fixing clips

Options available:

Lumen output

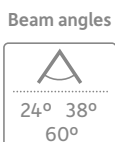

Colour temp.

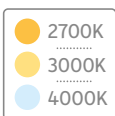

Bezel colour



Specification:

LED chip / CRI



Recessed

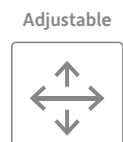

Cut-out Ø

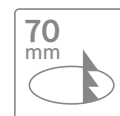

Dimming options

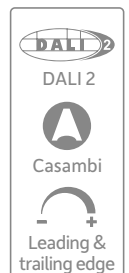



Project 90 Gimbal

Liberty's London / Regent Street, UK

Liberty's is described as the '*chosen resort of the artistic shopper*', a beautiful example of retail lighting at its best.

Project 90 Wallwash



For further information, technical details and downloads scan the QR code or visit www.illumina.co.uk/project-90-wallwash

A quintessential wallwash downlight available in a choice of beam angles and lumen outputs. Ideal for both highlighting and general lighting applications. Dimmable and emergency versions available.

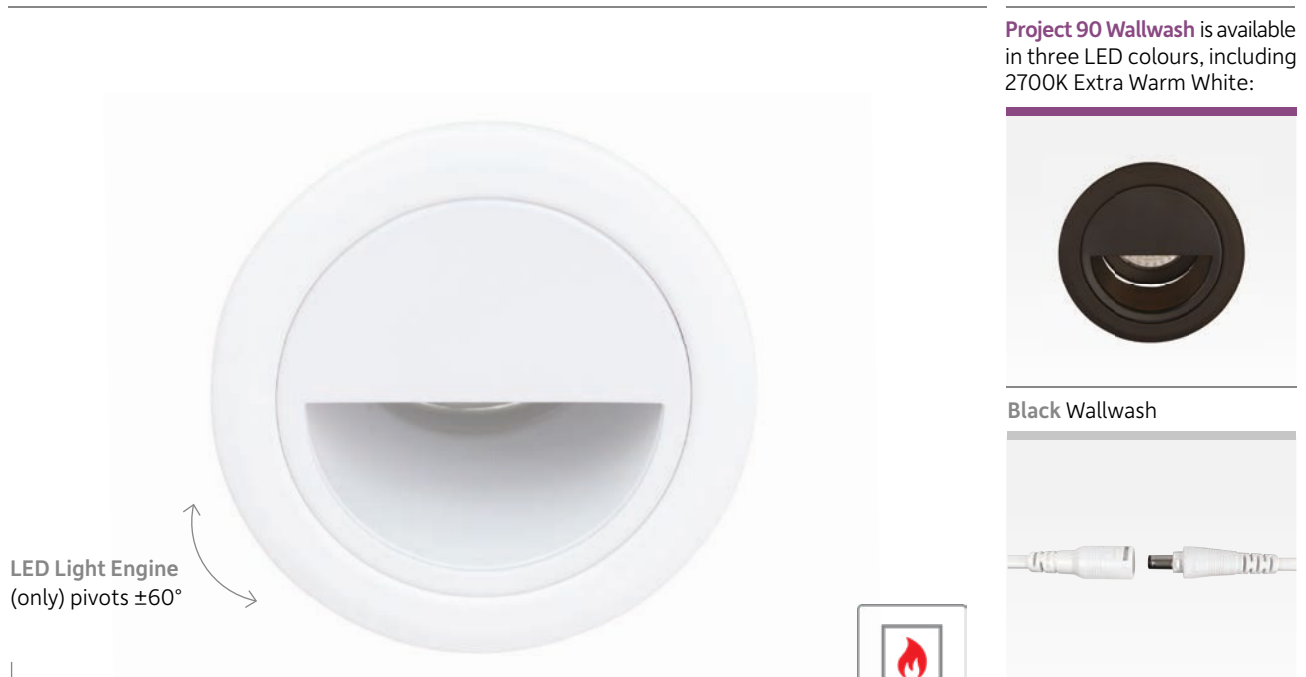

LED Light Engine (only) pivots $\pm 60^\circ$



Fire Hoods

Project 90 Wallwash is available in three LED colours, including 2700K Extra Warm White:

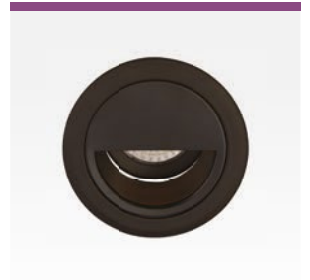

Black Wallwash



Easy twist & lock connector between downlighter & driver



Crisp and clean optic



925lm LED light engine



625lm LED light engine



Robust fixing clips

Options available:

Lumen output



Colour temp.

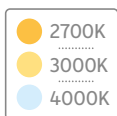

Bezel colour



Beam angles

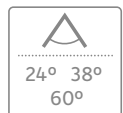

Bezel sizes



Emergency



Specification:

LED chip / CRI



Recessed



Cut-out Ø

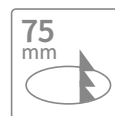

IP rating



Anti-glare



Driver



Dimming options





Project 90 wallwash

Charles Whitworth Suits / UK

Highlighting and accent is a must for this made to measure men's outfitters. Our Project 90 Wallwash was utilised to highlight and accentuate the intricate colours and textures to create the perfect look.

Framelight Mini



For further information, technical details and downloads scan the QR code or visit www.illumina.co.uk/framelight-mini

A classic and versatile lighting solution for multiple retail, leisure and commercial applications. Fully adjustable heads that pivot $\pm 45^\circ$ on two axes.



Heads pivot $\pm 45^\circ$ on two axes

Note: Lumen outputs quoted are per LED head

Framelight Mini comes in two colours and a variety of options:



Silver Grey body



Rear of luminaire



Crisp and clean optic



Integral heat sinks



Heads pivot $\pm 45^\circ$ on two axes



Recessed spring clips

Options available:

Lumen output



4 x 1250

Colour temp.



2700K
3000K
4000K

Body colour



White
Silver Grey

Beam angles

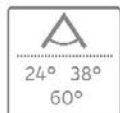

24° 38°
60°

Frame size



1 size

Specification:

LED chip / CRI



CREE
CRI > 90

Recessed



Adjustable

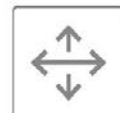

Cut-out



179x179 mm

IP rating



IP 20

Drivers



Included

Dimming options



DALI 2

Casambi

Leading & trailing edge

Framelight Mini

Southampton University / London, UK

A stunning example of residential University lighting. The campus has been described as the 'modern University with all the amenities'.

Proseal F



For further information, technical details and downloads scan the QR code or visit www.illumina.co.uk/proseal-f

This IP65, fire-rated, diecast aluminium downlight is designed for wet and humid environments, making it the complete solution for bathrooms, kitchens, exterior soffits, and fire-rated applications.

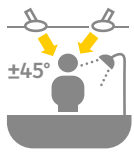

*LED Light Engine (only) pivots $\pm 45^\circ$ / Note: Can only be adjusted at installation



Crisp and clean optic



925lm LED light engine



625lm LED light engine



Robust fixing clips

Options available:

Lumen output



Beam angles



Colour temp.

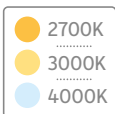

Bezel sizes

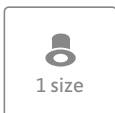

Bezel colour



Emergency



Specification:

LED chip / CRI



IP rating



Recessed



Fire rated



Cut-out Ø

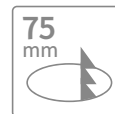

Adjustable*

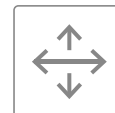

Driver



Dimming options





Proseal F

Hilton Hotel / UK

Award-winning, luxurious hotel chain encompassing a vibrant leading-edge design, offering singular service and remarkable local experiences in the world's most alluring locations.

Project 50



For further information, technical details and downloads scan the **QR code** or visit www.illumina.co.uk/project-50

This miniature range of aluminium, micro downlights has been designed specifically for discreet feature lighting. Useful in small retail display areas, under cabinet and shelf lighting.



Project 50 comes in a variety of styles and options:



Open option



Baffle option



Gimbal option



Crisp and clean optic



Integral heat sink

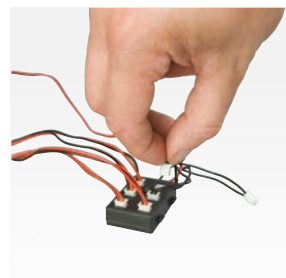

Easy plug and socket wiring

Options available:

Lumen output

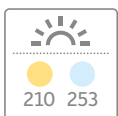

Beam angle



Colour temp.

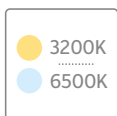

Bezel sizes

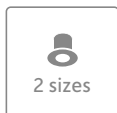

Bezel colour

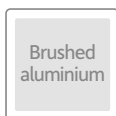

Style options

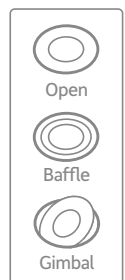

Specification:

LED chip / CRI



IP rating



Recessed



Adjustable

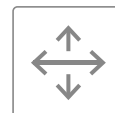

Cut-out Ø

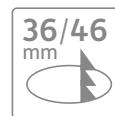

Accessories

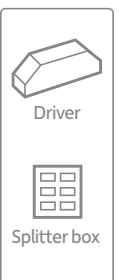



Project 50

Backes & Strauss / London, UK

An English company that designs and produces high-end timepieces and jewellery. Founded in 1789, it is one of the oldest diamond companies in the world. The London office, established in 1814, is described as 'A Jewel in the Crown'.

Fire Hoods



For further information, technical details and downloads scan the QR code or visit www.illumina.co.uk/fire-hoods

Fire Hoods; sometimes referred to as fire-rated hoods, are protective enclosures designed to be installed over the back of downlights. They serve a crucial role in maintaining the fire resistance of ceilings.



Fire Hood
Small square

Fire Hoods are available in 3 square sizes and one rectangle:



Medium square



Large square



5 spaces for multi-wiring



Inside



Rectangle for Framelight



Rectangle option

Options available:

Body sizes

	A	B	C
FH001	150	150	120
FH002	180	180	170
FH003	350	350	230
FH004	250	400	200



Look out for the **Fire Hood icon** throughout the catalogue and website to see which products are compatible:



Fire Hoods

Illuma's range of Fire Hoods are 60 minute rated and come in small, medium, large and rectangle sizes. All Fire Hoods are tested to BS476 Parts 22 & 23 standards.

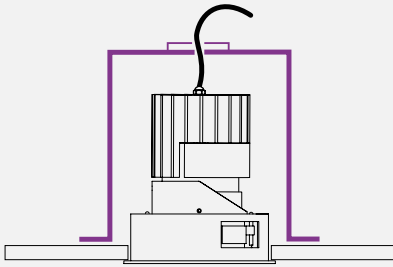

Square Fire Hood

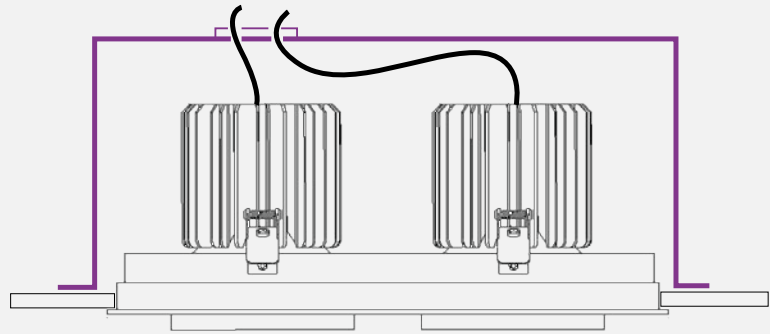

Rectangle Fire Hood

Features and benefits:

- Comes in 4 sizes to fit various Illuma products
- Easy installation
- Provides basic fire protection for non-fire rated downlights
- 5 spaces for multi-wire install

Look out for the **Fire Hood icon** throughout the catalogue and website to see which products are compatible:



Compatibility:

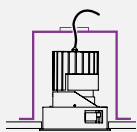

FH001 (small):

- > Project 90 625lm
- > Project 90 925lm Open / Gimbal
- > Infinia Mini
- > Infinia 900lm
- > Infinia 1200lm
- > Twizzle

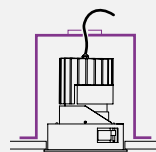

FH002 (medium):

- > Project 90 925lm Wallwash / Cones / Baffle
- > Infinia 2200lm
- > Infinia 2600lm
- > Arc
- > Hexseal Small
- > Highlux Fixed
- > Highlux Gimbal

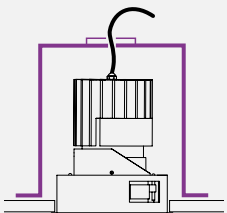

FH003 (large):

- > Lightseal
- > Single Framelight
- > Hexseal Large

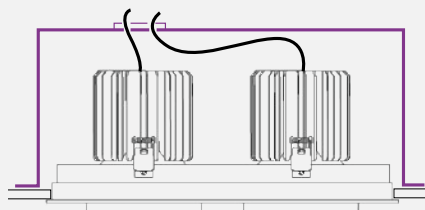

FH004 (rectangle)

- > Double Framelight

Commercial downlights

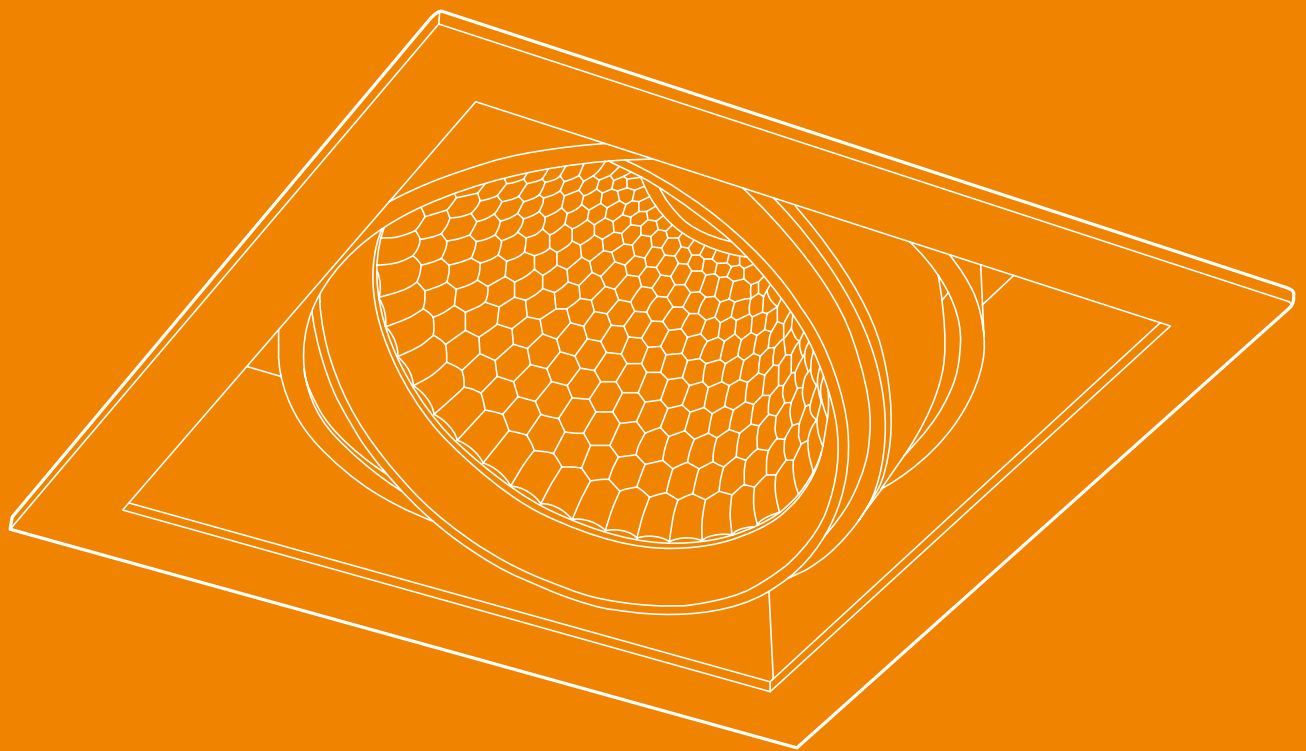

Commercial downlights are a popular way of providing light for office environments, circulation zones, office perimeter areas and retail applications.

Commercial downlights product range

07

An extensive range of highly innovative, commercial downlights suitable for multiple environments.



Hexseal 118

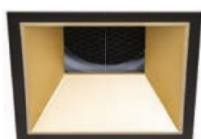

Infinia 120



Infinia Mini 124



Arc 126



Framelight 128



Highlux Fixed 130



Highlux Gimbal 132



Highlux Surface 134



Twinlux Low Glare 136



Lightseal 138



3D Ceiling Adaptor Ring 140

Hexseal



For further information, technical details and downloads scan the QR code or visit www.illumina.co.uk/hexseal

This low glare honeycomb design with multi-diffused optics, is flexible and very slimline making it ideally suited for multiple applications, with shallow ceiling voids. Available in two sizes with emergency and dimmable options.

Hexseal is a shallow low glare IP44 rated downlighter with a high CRI:



Small (2000lm) White



Large (3000lm) Black



Fire Hoods



Multi-diffused optics



Shallow profile (40mm depth)



Integral heat sink



Strong fixing clips

Options available:

Lumen output

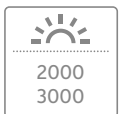

Colour temp.

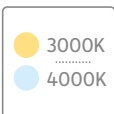

Bezel colour



Beam angles



Bezel sizes



Emergency



Specification:

LED chip / CRI



Recessed



Cut-out Ø

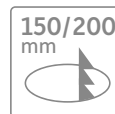

IP rating



Anti-glare



Driver



Dimming options

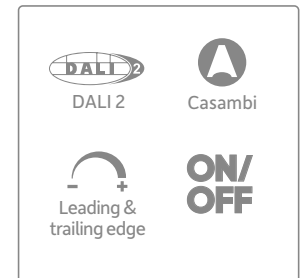

Hexseal

Cineplex / Birmingham, UK

The ultimate movie experience is fully enhanced and augmented by the Hexseal's multi-diffused optics and flexible slimline aesthetic, providing a truly immersive viewing experience.

Introducing

Infinia

Infinite possibilities.

A concept of unique customisable downlights with extensive options ideally suited for use in hotels, galleries and museums.



Dim to warm

The 900lm small head is a 'Dim to Warm'. At 100% it exhibits a Warm White light (3000K) but it can be dimmed down to the colour of Candle light (1800K).

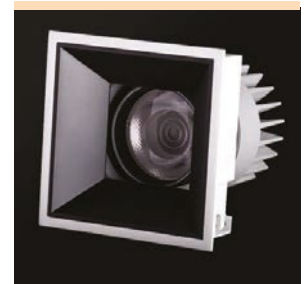

Features

Four lumen outputs. Four beam angles. Four bezel options. Multiple colour finishes. A variety of trim, colour & filtering options.



illumina /
products /
Infinia

Filter options:



Honeycomb

Reduces glare



Spreader

Elongates and spreads the luminares beam



Solite

Provides reduced glare delivering a soft beam without striations

Find your Infinia solution...



Round Black
Black chrome cone



Square Black
Black cone



Round White
Gold cone



Square White
Silver cone

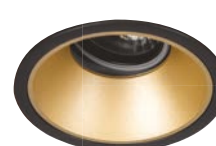

Round Black
Gold cone



Square Black
White wallwash

The Infinia range is available with an extensive number of options.

For specification, assistance or any special requests on the Infinia range please contact Illuma.

7 custom options

7 Options

The Infinia range can be customised with seven different options:

1

Colour temperature options

Our Infinia range of downlights is designed to cater for a diverse range of applications. Our light engines are available in three Kelvin temperatures, often referred to as CCT (correlated colour temperature). Choose from Extra Warm White (2700K), Warm White (3000K) and Neutral White (4000K) options.

2

Lumen output options

The Infinia family of LED downlights was designed with multi applications in mind. Choose from four lumen output options in three different sizes, including Small (900lm & 1200lm), Medium (2200lm) and Large (2600lm).

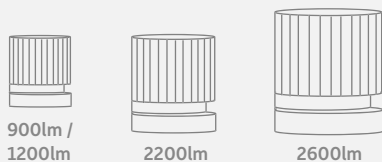

3

Dimming options

Controls are an important factor when it comes to creating the desired mood in any interior. Our Infinia family is available in a variety of dimming options. Choose from DALI 2, Casambi and Leading & Trailing Edge dimmable options.

4

Beam options

As beam angles are the lighting designer's pallet, the Infinia range offers a choice of beam angles, including 15°, 24°, 38° and 60° to suit all environments.



5

Filter options

Filters can control the intensity and projection of light. Choose from three filter options including Honeycomb, Spreader and Solite – must be specified at the time of ordering.

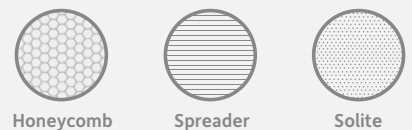

6

Bezel options

The Infinia family of LED downlights was specifically designed with versatility and flexibility in mind. Choose from four bezel options in three different sizes, including Square, Square Trimless, Round and Round Trimless.

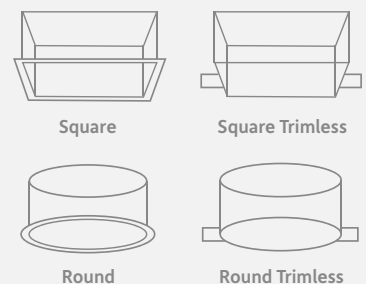

7

Trim / Colour options

The aesthetics of a lighting solution can complete a lighting design. The Infinia range is available in a variety of trim / colour options*.

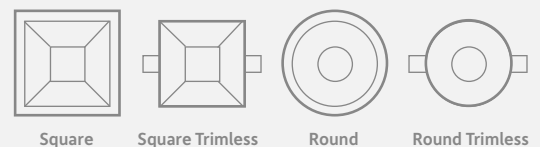

*Alternative colour finishes may be available by special request. Minimum order quantities may apply - enquire at the time of specification.

Infinia *continued*



For further information, technical details and downloads scan the QR code or visit www.illumina.co.uk/infinia

A comprehensive and unique range of downlights available in extensive options, designed with versatility and flexibility in mind. Fully adjustable heads that rotate 355° and pivot 30°. Emergency options available.

Honeycomb filter option

Head Rotates 355° / Pivots ±30°

Infinia comes in a variety of customisable styles and options:

Spreader filter option

Solite filter option

Fire Hoods

Options available:

<p>Lumen output</p> <p>900 1200 2200 2600</p>	<p>Colour temp.</p> <p>2700K 3000K 4000K</p>	<p>Dim to warm</p>	<p>Trim colour</p> <p>White Black Silver Gold Black chrome</p>	<p>Filters</p> <p>Honeycomb Spreader Solite</p>	<p>LED chip / CRI</p> <p>Luminus CRI >90</p>	<p>Recessed</p>	<p>Dimming options</p> <p>DALI 2 Casambi Leading & trailing edge</p>
<p>Beam angles</p> <p>15° 24° 38° 60°</p>	<p>Bezel sizes</p> <p>S M L</p>	<p>Emergency</p>			<p>IP rating</p> <p>IP 44</p>	<p>Adjustable</p>	

Bezel options

<p>Bezel colour</p> <p>White Black</p>	<p>Square cone</p>	<p>Square wallwash</p>	<p>Round cone</p>	<p>Round wallwash</p>	<p>Trimless square cone</p>	<p>Trimless square wallwash</p>	<p>Trimless round cone</p>	<p>Trimless round wallwash</p>
---	--------------------	------------------------	-------------------	-----------------------	-----------------------------	---------------------------------	----------------------------	--------------------------------

Infinia

Rhodus House / Canterbury, UK

Bespoke accommodation offering a range of studio and en-suite student rooms located in the heart of the city.

Infinia Mini



For further information, technical details and downloads scan the QR code or visit www.illumina.co.uk/infinia-mini

This miniature range of aluminium downlights has been designed specifically for discreet feature lighting. Ideal for small retail displays, hotel corridors and high-end residential applications.

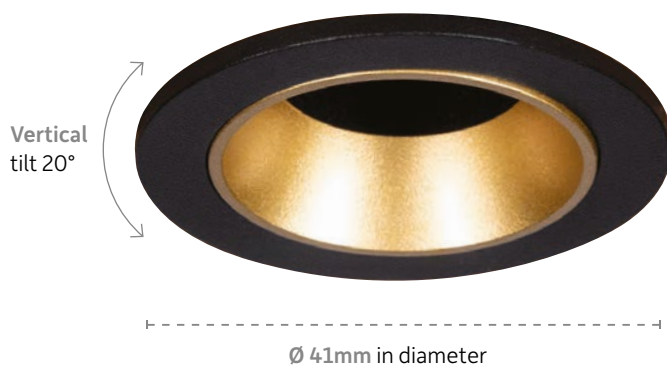

Comes complete with the following cone options to suit any interior:
Gold Cone / Chrome Cone / White Cone / Black Cone



Fire Hoods

Infinia Mini comes in a variety of styles and options:



White bezel with White Cone



Black bezel with Black Cone



Four cone options included



Crisp and clean optic



Inbuilt heat sink



Vertical tilt 20°

Options available:

Lumen output



Colour temp.

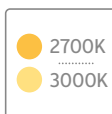

Bezel colour



Beam angle



Bezel size



Fire Hoods



Specification:

LED chip / CRI

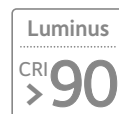

Recessed



Cut-out Ø

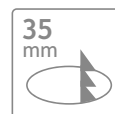

Driver



Dimming

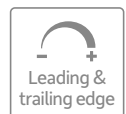

IP rating



Anti-glare



Adjustable

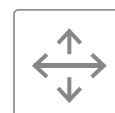

Infinia Mini

Hilton Hotel / UK

An award-winning hotel chain with luxurious properties, leading-edge design, exceptional service, and unforgettable local experiences in alluring locations.

Arc



For further information, technical details and downloads scan the **QR code** or visit www.illumina.co.uk/arc

A downlighting solution for retail, leisure and commercial applications where even illumination of a vertical surface is required. Fully adjustable head that rotates 355° and pivots ±75°.

Features an Alanod reflector which is 97% efficient!



Head rotates 355° / pivots ±75°

Arc comes in one body size, two colours and a range of beam angles:



White option



Black option



Fire Hoods



Crisp and clean optic



Integral heat sink



Adjustable head



Recessed spring clips

Options available:

Lumen output



Beam angles



Bezel size



Colour temp.

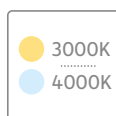

Bezel colour



Specification:

LED chip / CRI

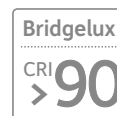

IP rating



Recessed



Adjustable

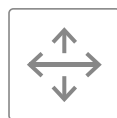

Cut-out Ø

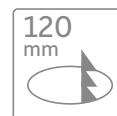

Driver



Dimming options





Arc

Liverpool Football Club Store / Liverpool, UK

One of England's most successful teams. The retail store situated in the heart of the city, contains remarkable trophies, souvenirs and items of clothing that represent the teams' passion for football.

Framelight



For further information, technical details and downloads scan the QR code or visit www.illumina.co.uk/framelight

A quintessential lighting solution for multiple retail, leisure and commercial applications that promotes a clean looking, unobtrusive ceiling.



Framelight is available in Single, 2 Way and 3 Way versions:



Options available:

Lumen output 2000 3000 4000	Colour temp. 3000K 4000K	Body colour White
Beam angles 24° 38°	Frame sizes Single 2 Way 3 Way	

Specification:

LED chip / CRI Citizen CRI >80	Recessed 	Cut-out (single) 170x170 mm 	Cut-out (2 Way) 170x320 mm 	Dimming options DALI 2 Casambi Leading & trailing edge
IP rating IP 20 	Adjustable 	Cut-out (3 Way) 170x480 mm 	Driver (s) Included	



Framelight

MCM / Knightsbridge, UK

MCM is a globally diverse, multicultural brand founded in the era of bright lights, jetset and disco, steeped in a rich heritage. Celebrated worldwide as an established and rising creative force.

Highlux Surface



For further information, technical details and downloads scan the QR code or visit www.illumina.co.uk/highlux-surface

A contemporary surface-mounted luminaire designed for leisure, and commercial environments. The Highlux Surface provides versatile general and feature lighting with a refined, modern aesthetic.



Highlux Surface comes in two colour options:



Black option



Side profile



Crisp and clean optic



Silver inner reflector



Surface fixing plate



Back of luminaire

Options available:

Lumen output



Colour temp.

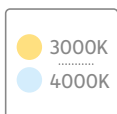

Body colour



Beam angles



Body size



Emergency



Specification:

LED chip / CRI



Surface mount

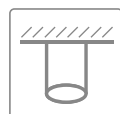

IP rating



Driver

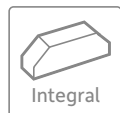

Dimming

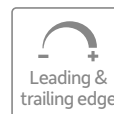

Highlux Surface

Holiday Villa / Palm Jumeirah, Dubai

With its clean design proportions and attractive reflector, the Highlux Surface is perfectly suited to any interior space that requires a well-proportioned surface-mounted solution.

Highlux Fixed



For further information, technical details and downloads scan the **QR code** or visit www.illumina.co.uk/highlux-fixed

A stylish range of timeless downlights available in one size with a choice of beam angles, lumen outputs and styles. Highly suited for retail, leisure and display applications that require general lighting.

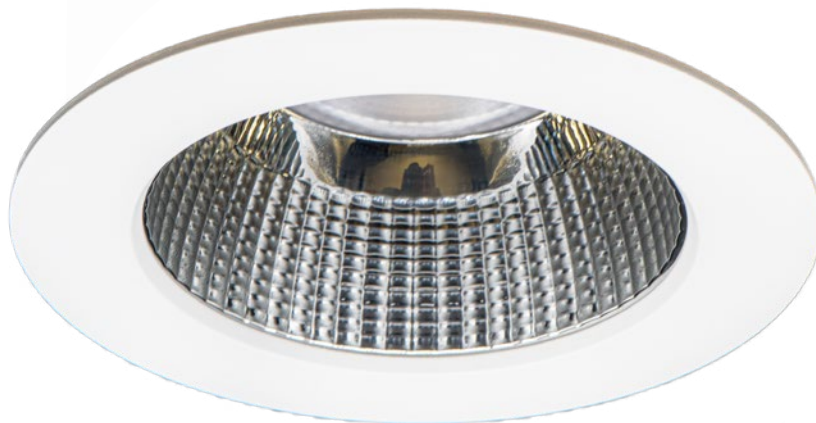

Highlux Fixed comes in one body size, two bezel colours and four different cone colour options:



White cone option



Black cone option



Gold cone option



Fire Hoods



Crisp and clean optic



Recessed fixing clips



Unique heat sink design

Options available:

Lumen output



Beam angles



Bezel size



Colour temp.

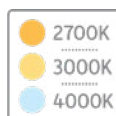

Emergency



Bezel colours



Cone colours



Specification:

LED chip / CRI



IP rating



Recessed



Cut-out Ø

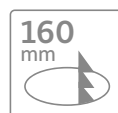

Dimming options





Highlux Fixed

Edit Suits / UK

Known for redefining modern tailoring, Edit Suits has built its reputation on craftsmanship, precision and a personalised approach to menswear. Their spaces are designed to reflect that same attention to detail — clean, refined and focused on the customer experience.

Highlux Gimbal



For further information, technical details and downloads scan the **QR code** or visit www.illumina.co.uk/highlux-gimbal

An adjustable range of timeless downlights available in a choice of beam angles, lumen outputs and styles. Its adjustable head allows for flexibility in retail, leisure and display applications that require general lighting.

Silver cone option in black



Head pivots $\pm 30^\circ$



Fire Hoods

Highlux Gimbal comes in one body size, two bezel colours and four different cone colours:



White cone option



Black cone option

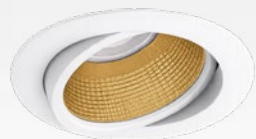

Gold cone option



Crisp and clean optic



Recessed fixing clips



Unique heat sink design

Options available:

Lumen output



Beam angles

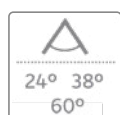

Bezel size



Colour temp.

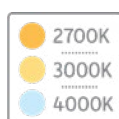

Bezel colours



Cone colours



Specification:

LED chip / CRI



IP rating



Recessed



Driver

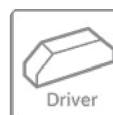

Cut-out Ø

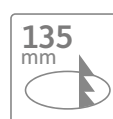

Adjustable

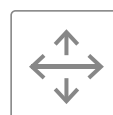

Dimming options

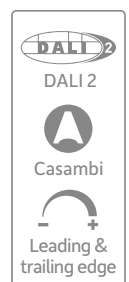



Highlux Gimbal

Noma Ceramics / UK

Noma Ceramics is a destination for timeless craftsmanship, bringing together carefully curated pottery and handmade pieces that celebrate texture, form and tradition. With a focus on understated elegance and natural materials, the space has been designed to create a calm, immersive experience where each piece can be appreciated in its truest form.

Twinlux Low-Glare



For further information, technical details and downloads scan the QR code or visit www.illumina.co.uk/twinlux-low-glare

Introducing our specialised downlighting solution for superior glare control. Available in two sizes and an emergency option for added safety. Experience the perfect balance of functionality and comfort.



Twinlux Low-Glare is available in two sizes and two lumen outputs:



Mini (3000lm)



Maxi (4500lm)



Crisp and clean optic



Quality construction



Pre-wired head



Integrated clip mechanism

Options available:

Lumen output

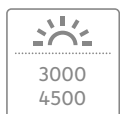

Colour temp.

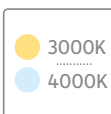

Bezel colour



Beam angles

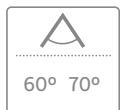

Bezel sizes



Emergency



Specification:

LED chip / CRI



Recessed



Cut-out Ø

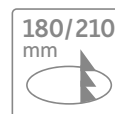

IP rating



Anti-glare



Driver



Dimming options

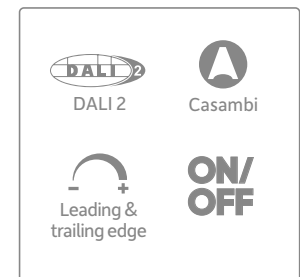

Twinlux Low-Glare

MINI / UK

Few cars can claim to be as iconic and recognisable as the MINI. The MINI wings logo perfectly captures the essence of being British. Sustainability is part of MINI's DNA.

Lightseal



For further information, technical details and downloads scan the **QR code** or visit www.illumina.co.uk/lightseal

This slim, IP65 rated downlight is ideally suited for applications with a low ceiling and shallow voids due to its wide beam angle and minimal recess depth. Available with emergency and dimmable options.



Lightseal is a shallow IP65 rated downlighter with an opal diffuser:



Maxi White option (2200lm)



Mini Black option (1700lm)



Fire Hoods

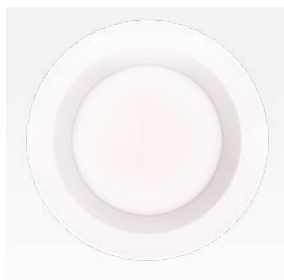

Dual layered diffuser



Shallow profile



Integral heat sink



Strong fixing clips

Options available:

Lumen output

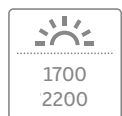

Colour temp.

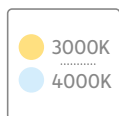

Bezel colour



Beam angles

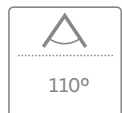

Bezel sizes



Emergency



Specification:

LED chip / CRI

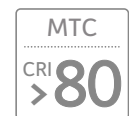

Recessed



Cut-out Ø



IP rating



Driver



Dimming options

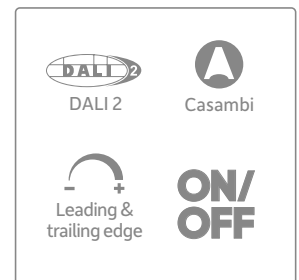

Lightseal

Polmar Foods Supermarket / London, UK

Their bright and spacious, modern new store in Wembley offers a wide variety of products from Eastern Europe.

3D Ceiling Adaptor Ring



For further information, technical details and downloads scan the **QR code** or visit www.illumina.co.uk/3D-ceiling-adaptor-ring

The 3D Ceiling Adaptor Ring comes in two sizes and allows products to be recessed into ceilings with larger cutout holes than the products' bezel, for use with Illuma's ARC commercial downlights.



3D Ceiling Adaptor Ring are available in two sizes and can be **black** or **white**:



3D-CAR220 **Black (small)**



3D-CAR240 **White (large)**



Accurately 3D printed to size



Bezel sits smoothly to ceiling



Non-slip textured base

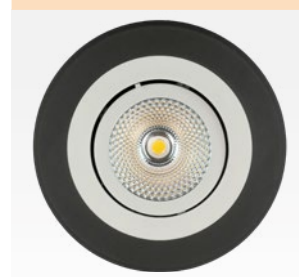

Black option on **ARC160**

Options available:



NB: Enquire for special requests. Different sizes may be available as a special.

3D Ceiling Adaptor Ring

07



3D-CAR220 (small)

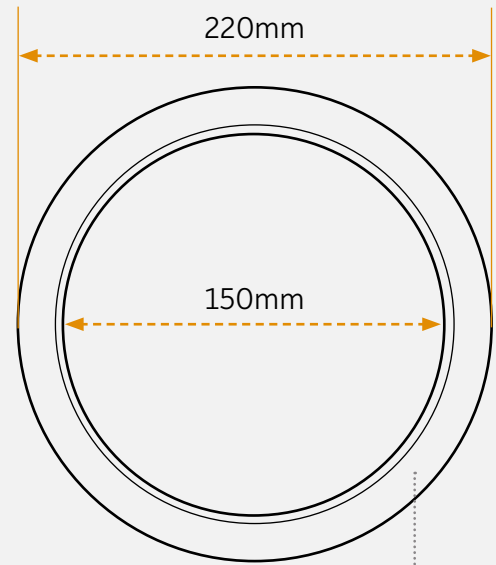
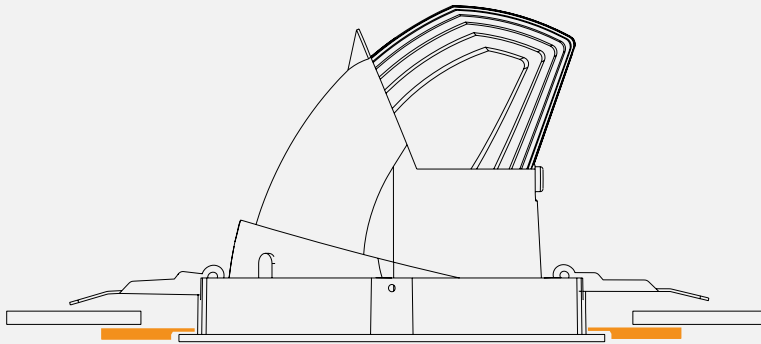

Features and benefits:

- For use with [ARC 160](#)
- Perfectly flush bezel for smooth finish
- 3D Printed using sustainable materials
- Easy installation



3D-CAR240 (large)

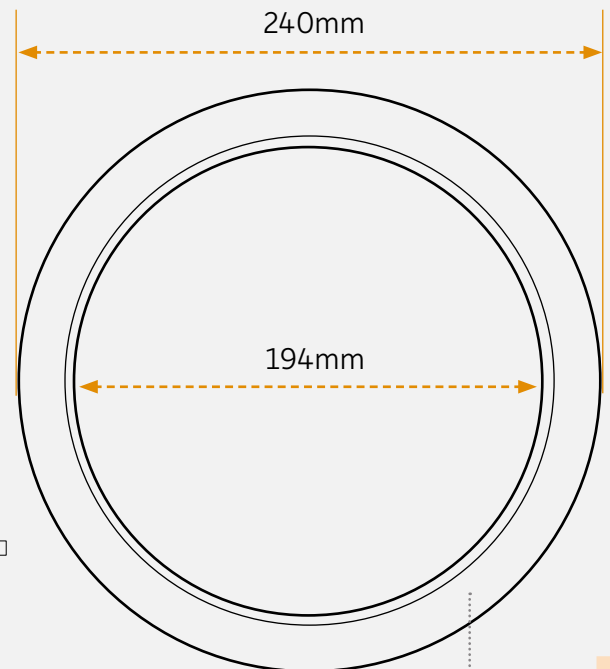
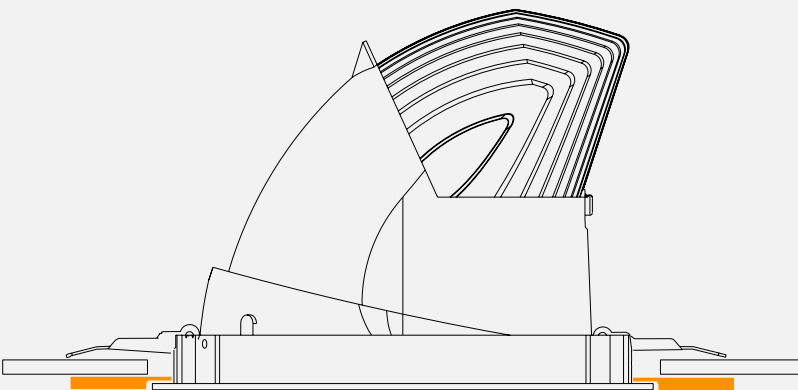

Features and benefits:

- For use with [ARC 200](#)
- Perfectly flush bezel for smooth finish
- 3D Printed using sustainable materials
- Easy installation

Feature

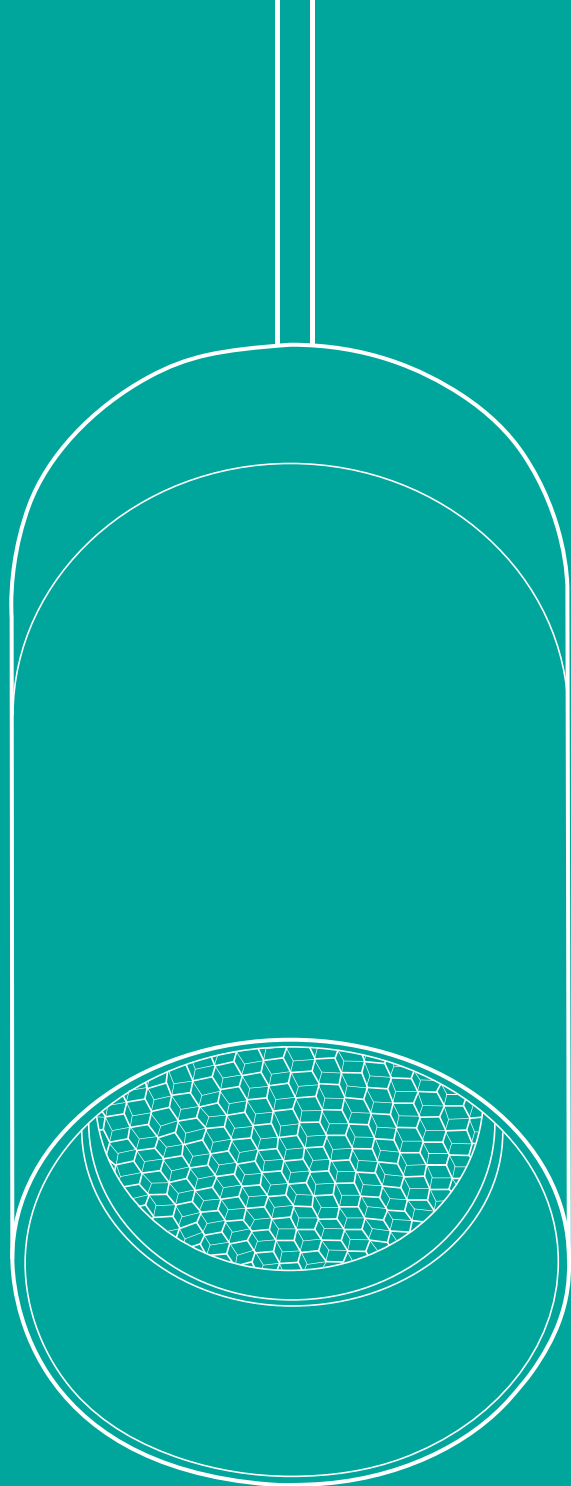

Feature lighting extends beyond ambient and accent lighting to accentuate desired characteristics, create moods or orientation functions. Feature lighting provides an array of solutions for many diverse applications.

Feature product range

A pioneering range of stylish feature solutions, ideal for environments requiring mood creation or to create an eye-catching focal point.



Ambit 144



Uniseal 146



Zube Pendant 148



Zube Pendant Shades 150



Disk Pendant 152



Disk Wall 154



Upline 156



Via 158

Ambit



For further information, technical details and downloads scan the QR code or visit www.illumina.co.uk/ambit

A stylish halo style pendant available in three sizes. Ideally suited for restaurants, bars, cafes, foyers and receptions where it can create a stunning decorative piece.

Selectable colour temperature:

3000K

4000K

Ambit is available in 3 ring sizes 600mm, 1000mm and 1500mm. Double Ambit only available in a combination of 600mm & 1000mm sizes.

White small (600mm)

Gold medium (1000mm)

Bronze large (1500mm)

Surface Mount Base

Adjustable suspension wires

Double (combination of 600 & 1000mm only)

Options available:

<p>Lumen output</p> <table border="1" style="font-size: 8px; width: 100%;"> <tr><td>WH</td><td>BL</td></tr> <tr><td>GD</td><td>BR</td></tr> </table> <table border="1" style="font-size: 8px; width: 100%;"> <tr><td>S</td><td>2800</td><td>2400</td></tr> <tr><td>M</td><td>5600</td><td>4800</td></tr> <tr><td>L</td><td>8400</td><td>7200</td></tr> </table>	WH	BL	GD	BR	S	2800	2400	M	5600	4800	L	8400	7200	<p>Colour temp.</p> <p>Selectable</p> <p>3000-4000K</p> <p>Body sizes</p>	<p>Surface Mount</p>	<p>Body Colour</p> <div style="border: 1px solid black; padding: 2px; margin-bottom: 2px; text-align: center;">White</div> <div style="border: 1px solid black; padding: 2px; margin-bottom: 2px; text-align: center;">Black</div> <div style="border: 1px solid black; padding: 2px; margin-bottom: 2px; text-align: center;">Gold</div> <div style="border: 1px solid black; padding: 2px; text-align: center;">Bronze</div>
WH	BL															
GD	BR															
S	2800	2400														
M	5600	4800														
L	8400	7200														

Specification:

<p>LED chip / CRI</p> <div style="border: 1px solid black; padding: 5px; text-align: center;"> illuma CRI >80 </div> <p>IP rating</p> <div style="border: 1px solid black; padding: 5px; text-align: center;"> IP 20 </div>	<p>Adjustable</p> <div style="border: 1px solid black; padding: 5px; text-align: center;"> </div> <p>Wide beam</p> <div style="border: 1px solid black; padding: 5px; text-align: center;"> </div>	<p>Bi-directional</p> <div style="border: 1px solid black; padding: 5px; text-align: center;"> </div>	<p>Dimming options</p> <div style="border: 1px solid black; padding: 5px; text-align: center;"> <p>DALI 2</p> <p>Leading & trailing edge</p> </div>
--	--	---	---



Ambit

Celeste Grand Hotel / UK

This premium hotel chose the Ambit to highlight the reception waiting area, creating a modern and comfortable atmosphere.

Uniseal



For further information, technical details and downloads scan the **QR code** or visit www.illumina.co.uk/uniseal

A robust, IP65 rated solution, highly suitable for general and ambient lighting environments. Including schools, universities, retail, leisure and commercial applications.



Microwave sensor option available

Uniseal

comes in one size and two cover options:



Open black option



Eyelid black option

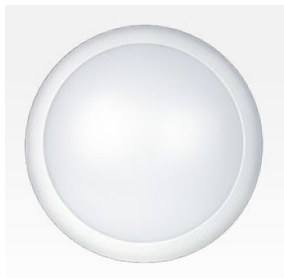

Opal diffuser



Rounded design



Side conduit entry

Options available:

Lumen output

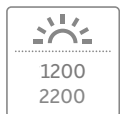

Colour temp.

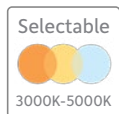

Body colour



Surface mount



Microwave sensor



Beam angles



Body size



Cover style



Vertical mount



Emergency



Specification:

LED chip / CRI



Wide beam



Dimming options



IP rating



Impact resistant





Uniseal

Southampton University Student Accommodation, Southampton / UK

The Uniseal was the perfect choice for the university halls due to its impact resistance and anti tamper screws.

2ube Pendant



For further information, technical details and downloads scan the QR code or visit www.illumina.co.uk/2ube-pendant

A stylish and compact pendant. Ideally suited for restaurants, bars, cafes, foyers and receptions where low glare feature lighting is required to create a warm inviting mood.



The 1470lm head is a Dim to warm. At 100% it exhibits a Warm White light (3000K) but it can be dimmed down to 2000K which is close to the colour of Candle light (1800K)



2ube Pendant comes with a 1350mm power cable as standard. **Recessed Mono Point** and **Surface Plate** can be adjusted on site. **Track Adaptor** versions are made to order and the length of power cable must be specified at the time of ordering:



Honeycomb Louvre option



Standard option



Surface Plate option



Recessed Mono Point option



Track adaptor option

Options available:

Lumen output



1470

Body colour



Black

Track mount



Recessed mono

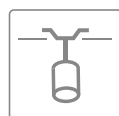

Option styles



Standard

LED chip / CRI



Bridgelux
CRI >80

Mono cut-out Ø

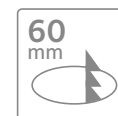

60 mm

Dimming



Dim to warm

Beam angles



24°

Body size



1 size

Surface mount



Accessories



shades

Option styles

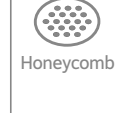

Honeycomb

IP rating



IP
20

Anti-glare



2ube Pendant

Coffee House Ninety Nine / UK

This cosy independent coffee shop, known for its unique coffees from around the world, provides a diverse selection for customers. A relaxed and inviting atmosphere encourages customers to linger and socialise. The 2ube Pendant emphasises this ambient tone by setting the mood with its custom dim to warm feature.

2ube Pendant Shades



For further information, technical details and downloads scan the **QR code** or visit www.illumina.co.uk/2ube-pendant-shades

A stylish and unique 3D Printed shade accessory for the 2ube pendant. Ideally suited for restaurants, bars, foyers and receptions where low glare feature lighting is required to create a warm and inviting mood.



The 1470lm head is a **Dim to warm**. At 100% it exhibits a Warm White light (3000K) but it can be dimmed down to 2000K which is close to the colour of Candle light (1800K)



Varies on design (max 220mm)

Varies on design (max 200mm)

Each shade is made from PLA - Bioplastic which is a plant based renewable resource.

2ube Pendant Shades are available in 4 unique shade designs and 7 colours with mix of finishes.



Swirl in matte black option



Shade style options:



Spire option



Bloom option



Swirl option



Ridge option

Sustainably made

Shade colour options:





2ube Pendant Shades

The Golden Lotus / UK

This warm and intimate dining space at The Golden Lotus is brought to life by the 2ube Pendant Shades. Their soft, diffused glow creates a rich ambience, enhancing the deep red palette and adding a sculptural focal point above each table.

Disk Pendant



For further information, technical details and downloads scan the QR code or visit www.illumina.co.uk/disk-pendant

A contemporary range of circular pendants in different sizes. Perfect for cafes, restaurants, foyers and chill out areas in which a comfortable but practical level of illumination is required.



Disk Pendant comes in three sizes and a variety of options:



Small 120mm Ø / 1200lm



Medium 200mm Ø / 2500lm



Large 300mm Ø / 3000lm



Opal diffuser



Adjustable cable 1650mm



Recessed spring clips

Options available:

Lumen output

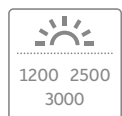

Colour temp.

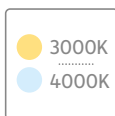

Body colour



Recessed mono



Beam angles



Body sizes

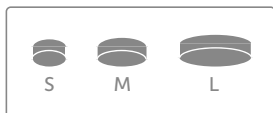

Specification:

LED chip / CRI



Mono cut-out Ø



IP rating



Wide beam



Dimming options





Disk Pendant

The Park Hotel / UK

This luxurious and quirky lobby serves as a hub for guests to gather and interact. A modern and sleek look, designed with elegant décor creates a memorable and enjoyable experience for the guests. The Disk Pendant compliments this space perfectly, creating an atmospheric ambience.

Disk Wall



For further information, technical details and downloads scan the **QR code** or visit www.illumina.co.uk/disk-wall

A contemporary adjustable wall light ideal for providing indirect, glare-free lighting for multiple interiors. Perfect for providing a diffused uplight for any interior space.

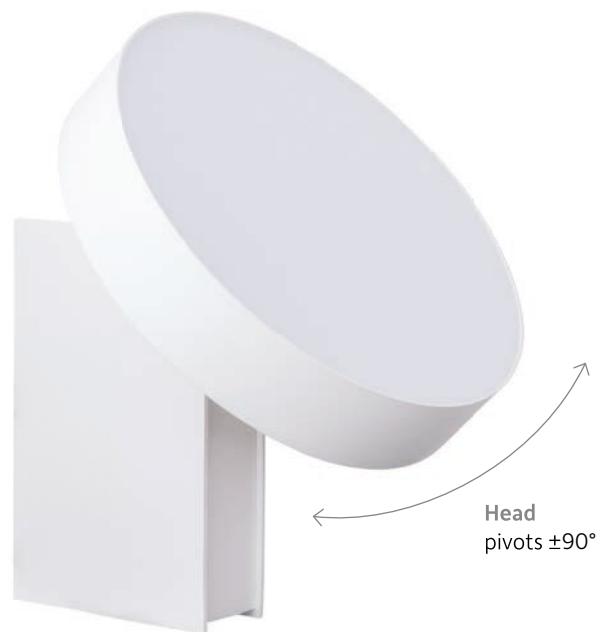

Opal diffuser



Head pivots $\pm 90^\circ$



Positioned vertically



Positioned horizontally

Options available:

Lumen output



2500

Colour temp.

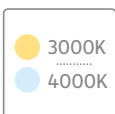

3000K
4000K

Body colour



White

Beam angles



120°

Body size



1 size

Vertical mount



Specification:

LED chip / CRI



Seoul
CRI > 80

Adjustable

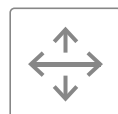

IP rating



IP
20

Wide beam



Dimming



DALI 2

Disk wall

Milner Hall / Winchester, UK

A former chapel in Winchester, one of the oldest structures in the city of great architectural and religious importance. The Disk Wall perfectly marries the ancient and modern aspects of this building.

Upline



For further information, technical details and downloads scan the QR code or visit www.illumina.co.uk/upline

A slim direct and bi-direct switchable wall light providing low-glare lighting for modern interiors. With an IP54 rating, the Upline can also be used for exterior applications.

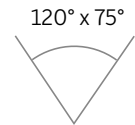
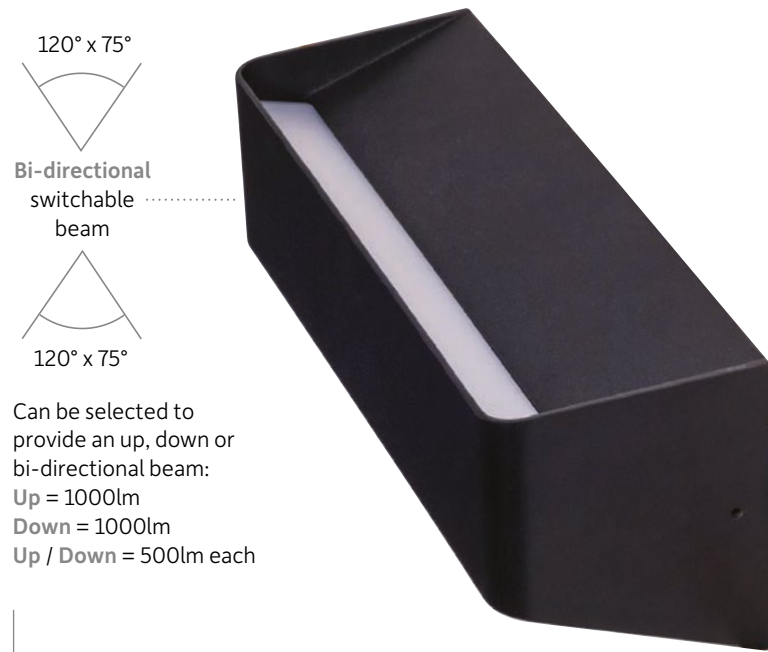

Bi-directional switchable beam



Can be selected to provide an up, down or bi-directional beam:
 Up = 1000lm
 Down = 1000lm
 Up / Down = 500lm each

Upline is a slim, unobtrusive wall light that is suitable for interior or exterior use:



White option



Black option



Straight on view of front profile



Slim profile



View of top diffuser

Options available:

Lumen output

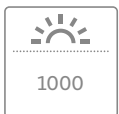

Colour temp.

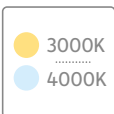

Body colour



Beam angles



Body size



Vertical mount



Specification:

LED chip / CRI



Bi-directional

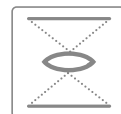

IP rating



Anti-glare



Dimming

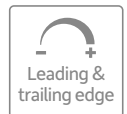



Upline

Private Apartments / Northern Quarter, Manchester, UK

A large luxury development in Manchester's Northern Quarter used the Upline due to its clean lines and flexibility. It was utilised in both interior and exterior areas, adding significantly to the overall look of the development.

Via



For further information, technical details and downloads scan the QR code or visit www.illumina.co.uk/via

An unobtrusive range of interior lighting modules and covers which can be used for orientation and decorative lighting purposes. Available with three aluminium cover styles.



Note: The Flush cover requires a recess

Via comes in a variety of cover styles and options:



Flush cover



Dome cover



Eyelid cover



Choose a base unit



Install the base unit



Attach the appropriate cover

Options available:

Lumen output

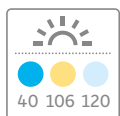

40 106 120

Beam angles



120°

Colour temp.

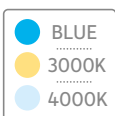

BLUE
3000K
4000K

Body size



1 size

Cover colour



Anodised aluminium

Semi-recessed



Surface mount

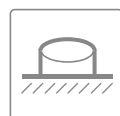

Base unit

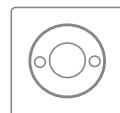

Cover styles

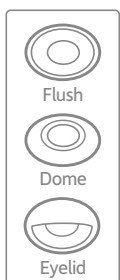

Flush

Dome

Eyelid

Specification:

LED chip / CRI



Luxeon
CRI > 80

IP rating



IP
20

Recess Ø



42 mm

Wide beam



Accessories

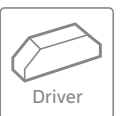

Driver

Via

Wembley Farm House / Keyworth, UK

A home with a mix of modern and antique styles. Based in the countryside with amazing interiors recently refurbished. The unobtrusive Via fits perfectly into this artefactual residence.

Exterior product range

A unique range of stylish exterior solutions, ideal for environments requiring mood and feature lighting.



Signspot

162



Signled

164



Pathfinder

166



Camino

168

Signspot



For further information, technical details and downloads scan the **QR code** or visit www.illumina.co.uk/signspot

This robust IP67 rated, exterior spotlight has been developed specifically for exterior use. With its variable beam, it provides the perfect flexible solution for highlighting signage or horticultural features.

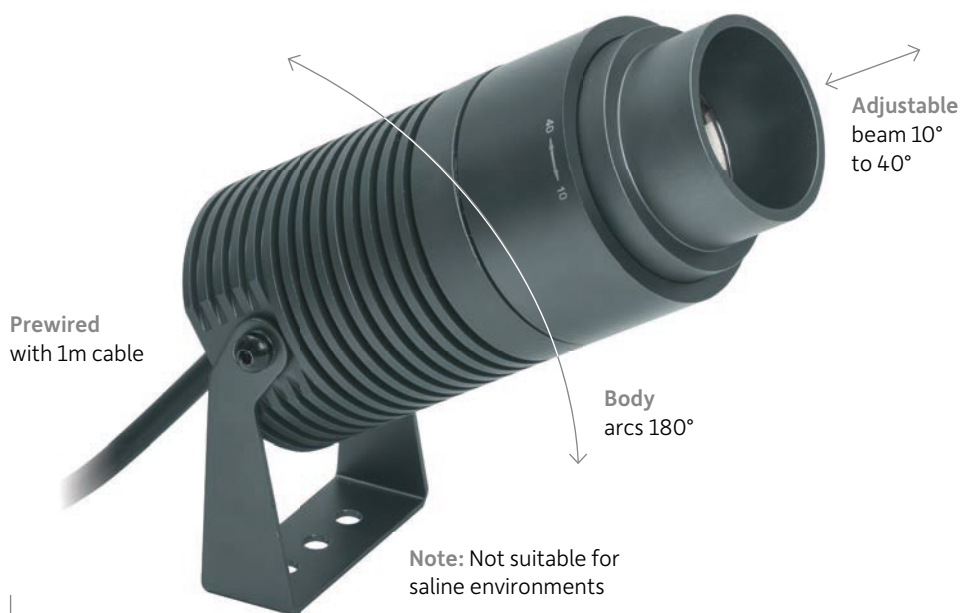

Signspot is a high quality adjustable beam exterior spotlight:

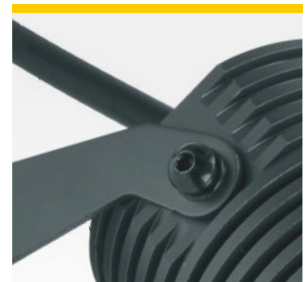

Allen key bolt lock



IP67 rated (waterproof)



Optic with inbuilt water drain



Mounting bracket included



Ground spike included



High quality metal gland

Options available:

Lumen output 750	Colour temp. 4000K	Body colour Anthracite Grey	Ground spike Included
Beam angles 10 - 40°	Body size 1 size	Surface mount Surface mount	

Specification:

LED chip / CRI CREE CRI >80	Anti-glare 	Variable beam
IP rating IP 67	Adjustable 	



Signspot

Church of St. Edward King & Martyr / Castle Donington, UK

A church that has been in the heart of the Castle Donington community for over 900 years. The Signspot blends discreetly into the church yard environment, adding emphasis to the Church's information board.

Signled



For further information, technical details and downloads scan the QR code or visit www.illumina.co.uk/signled

The complete lighting solution for interior and exterior signage. Available over two colour temperatures in a variety of lengths, its ideal for the even illumination of large format signs.

Signled comes in two colours and a range of sizes:

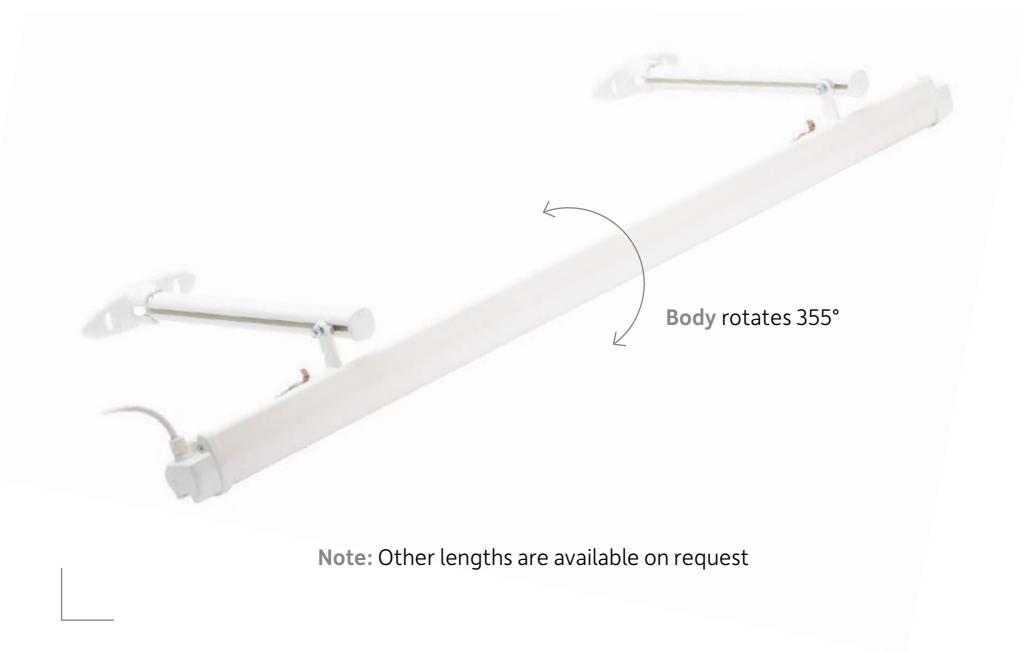

Body rotates 355°

Note: Other lengths are available on request



300mm wall brackets included



High quality metal glands



Magnifying optic



Adjustable arms



750mm of flex included, fed into the left side (viewed from street)

Options available:

Lumen output

☀️	
● 3000K	● 6000K
XS 447	497
S 1098	1221
M 2198	2442
L 3298	3663
XL 3663	4070

Colour temp.

● 3000K	● 6000K
---------	---------

Beam angles

△
120°

Body colour

White
Black

Surface mount

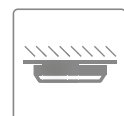

Vertical mount



Body sizes / Length (mm)

XS	S	M	L	XL
610	1524	3048	4572	6096

Specification:

LED chip / CRI

Nichia
CRI >80

Adjustable

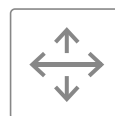

IP rating

IP
65

BOXPARK

URBANEARS

ABUZE

ONEPIECE

ONE TRUE SAXON

BOXFRESH

Signled

BOXPARK / London, UK

BOXPARK brings communities together by providing the best street food, drinks and entertainment under one roof. The three locations are in the heart of their respective London boroughs, each one offering a unique experience.

Pathfinder



For further information, technical details and downloads scan the **QR code** or visit www.illumina.co.uk/pathfinder

Our Pathfinder is tailor-made for tubular profiles, making it perfect for handrails that provide safe navigation for routes and walkways. It is offered in four different lumen outputs over two lengths, all of which are IP67 rated.

Pathfinder is available in two lengths with two LED colour temperature options:



Anodised aluminium



Joinable fittings



Accessories

Options available:

Lumen output

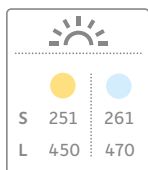

Colour temp.

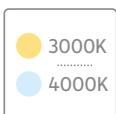

Body colour



Body sizes

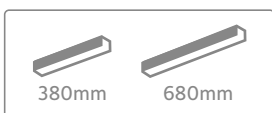

Specification:

LED chip / CRI



IP rating



380mm option Cut-out



680mm option Cut-out



Joinable



Accessories

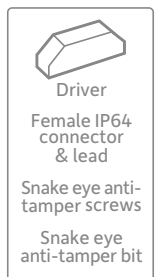



Pathfinder

Brisbane City Council / Brisbane, Australia

The council have installed the Pathfinder handrail lighting system on pedestrian developments throughout the city. This excellent system is an ideal solution for dark pathways and stairs.

Camino



For further information, technical details and downloads scan the QR code or visit www.illumina.co.uk/camino

An unobtrusive range of exterior lighting modules which can be used for orientation and decorative lighting purposes. Available in three, marine grade stainless steel, cover styles.

Camino is available in three marine grade steel cover options:



Note: The Flat cover requires a recess

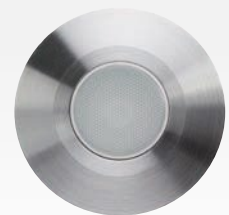

Flat stainless steel cover

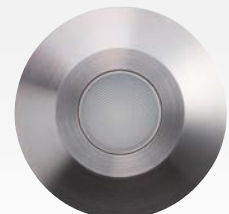

Cone stainless steel cover

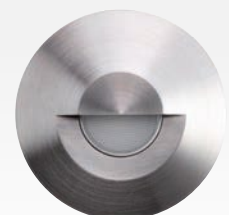

Step stainless steel cover



Choose a base unit

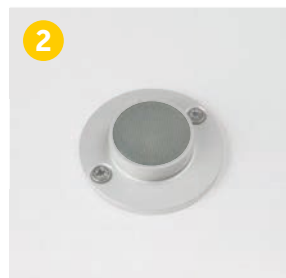

Install the base unit

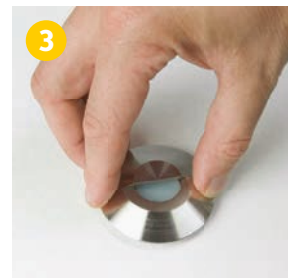

Attach the appropriate cover

Options available:

Lumen output

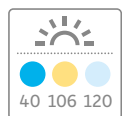

Beam angles



Colour temp.

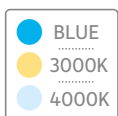

Body size

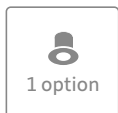

Cover colour



Semi-recessed



Surface mount

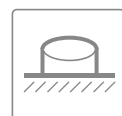

Base unit

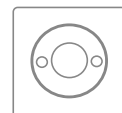

Option styles

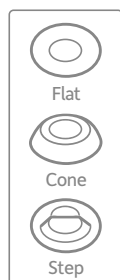

Specification:

LED chip / CRI



IP rating



Recess Ø

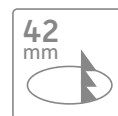

Wide beam



Accessories

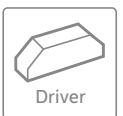



Camino

Monty's Bakehouse / Surrey, UK

This Surrey-based company offers eco-friendly food-to-go solutions for sports venues, airports, universities, and offices. Monty's are dedicated to providing high-quality, sustainable meals with thoughtful packaging.

Emergency



Emergency lighting offers a variety of solutions that allow for the safe evacuation of a premise when the mains supply fails.

Emergency product range

A reliable range of designated emergency solutions for many diverse applications and environments.



Emlux Duo 172



Emlux Twinspot 174



Emlux Discrete 176



Emlux Blade 178



Emlux Sign 180



Emlux Bulkhead 180



Emlux Sign 180

Emlux Duo



For further information, technical details and downloads scan the QR code or visit www.illumina.co.uk/emlux-duo

A non-maintained, emergency luminaire for universal applications that can be track or surface mounted, allowing flexibility. Ideal for helping guide occupants safely during an evacuation.

Note: Auto Self Test runs periodically, including during the night and automatically carries out all weekly / annual tests



Emlux Duo is a flexible Non-maintained Emergency that is Auto Test as standard:



Black surface option



White surface option

Non-maintained: Comes on when the power supply to the lighting fails



Unobtrusive design

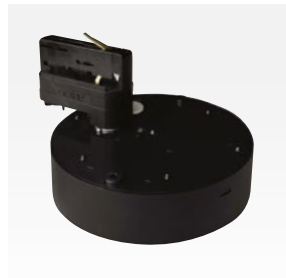

Track mounted option



Remote test controller



Surface is BESA mountable

Options available:

Lumen output



150

Body colour



White

Black

Surface mount



Track mount



LED chip / CRI



Nichia

CRI > 80

Emergency



Beam angles

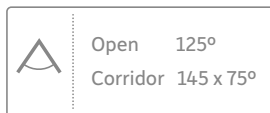

Open 125°
Corridor 145 x 75°

Body size



1 size

Control options



DALI 2
DALI 2

IP rating



IP

20

Accessories

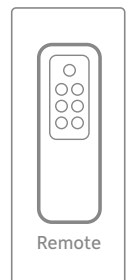

Remote



Emlux Duo

Caffè Nero / Belfast, Northern Ireland

A premium award winning Italian-influenced coffeehouse company, founded in 1997. Our range of products perfectly enhance their warm and welcoming atmosphere.

Emlux Twinspot



For further information, technical details and downloads scan the QR code or visit www.illumina.co.uk/emlux-twinspot

A maintained or non-maintained twin head emergency luminaire for universal applications that can be track or surface mounted. Ideal for helping guide occupants safely during an evacuation.



Heads rotate 355° & pivot ±80°

Emlux Twinspot is a Maintained and Non-maintained product:



Black body



White body

Maintained: Always on and stays on when the power supply to the lighting fails
Non-maintained: Comes on when the power supply to the lighting fails



Adjustable head with 30° beam



Heads rotate 355° & pivot ±80°



Inbuilt status indicator



Track mountable option

Options available:

Lumen output



Body colour



Track mount



Surface mount



Beam angles



Body size



Vertical mount



Specification:

LED chip / CRI



Emergency



IP rating



Adjustable

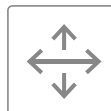

10

12

A

B

Emlux Twinspot

Illuma / Castle Donington, UK

Illuma is a leading lighting specialist, manufacturing an extensive range of high-quality commercial and industrial lighting solutions. The Emlux Twinspot was the perfect addition to our warehouse.

Emlux Discrete



For further information, technical details and downloads scan the QR code or visit www.illumina.co.uk/emlux-discrete

A small and discreet recessed non-maintained emergency luminaire that is Auto Test/Self Test as standard, is ideal for assisting occupants during the evacuation of spaces.

Note: Auto Self Test runs periodically, including during the night and automatically carries out all weekly / annual tests



Non-maintained: Comes on when the power supply to the lighting fails

Emlux Discrete is a small Non-maintained Emergency that is Auto Test as standard:



Open option 125° lens



Corridor option 145° x 75° lens



White Open option



Black Open option



Remote test controller



Through the hole battery pack

Options available:

Lumen output



Body colour



Option styles

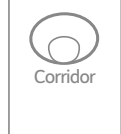
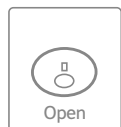

Beam angles

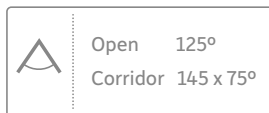

Body size

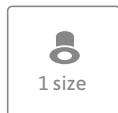

Specification:

LED chip / CRI



Cut-out Ø



Recessed

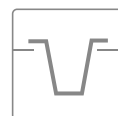

Accessories

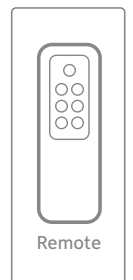

IP rating



Emergency





Emlux Discrete

Pulse of Perfumery / Knutsford, UK

This dedicated fragrance outlet utilises over 60 years of experience in creating bespoke perfumes and promoting brand names in the UK. It is a welcoming, non-intimidating space where our discreet emergency blends unobtrusively with the décor.

Emlux Blade



For further information, technical details and downloads scan the QR code or visit www.illumina.co.uk/emlux-blade

A range of maintained or non-maintained emergency escape route signs which can be surface or track mounted. Ideal for helping guide occupants safely during the evacuation of spaces.

Note: The correct directional legend must be specified when ordering.



Maintained:
Always on and stays on when the power supply to the lighting fails
Non-maintained:
Comes on when the power supply to the lighting fails

Emlux Blade comes in a variety of styles and options:



Track mount black option



Track mount white option



Slim profile



Robust design



Test button



Surface mount black option

Options available:

Body colour



Surface mount

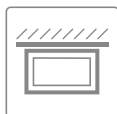

Body sizes



Track mount



Specification:

LED chip / CRI



Emergency



IP rating





Emlux Blade

Skoda, Mansfield / UK

The EMLUX Blade was chosen for the prestigious Skoda brand as it fits in seamlessly with the design of the store by being situated on Illuma's 3-Circuit track.

Emlux Sign



For further information, technical details and downloads scan the QR code or visit www.illumina.co.uk/emlux-sign

A wide range of maintained or non-maintained emergency escape route signs with a variety of legends. Ideal for helping guide occupants safely during evacuation of spaces.

Note: All versions include all legends apart from the Wall version which needs the legend specifying at the point of ordering

Maintained:
Always on and stays on when the power supply to the lighting fails
Non-maintained:
Comes on when the power supply to the lighting fails



Emlux Sign comes in a variety of styles and options:



Wall option



Surface mounted option



Slim profile Bulkhead



Robust clear cover



With included legend applied



Suspended option

Options available:

<p>Body colour</p> <p>White</p>	<p>Surface mount</p>	<p>Suspended</p>	<p>Option styles</p> <p>Bulkhead Wall</p> <p>Suspended Surface</p>
<p>Body sizes</p> <p>4 sizes</p>	<p>Vertical mount</p>		

Specification:

<p>LED chip / CRI</p> <p>Nichia CRI >80</p>	<p>Emergency</p>
<p>IP rating</p> <p>IP 20</p>	

Dogwood

Dry Dog Food

Emlux Sign

Pets Corner / UK

Pets Corner is an ethical pet care specialist, with over 140 stores across the UK. Its main area of business is selling natural pet foods, accessories and treatments predominantly for dogs and cats, but also for small animals, reptiles, birds, wildlife and tropical / cold-water fish.

Index by cutout

Cutout (mm)	Recess (mm)	Product range name	Type	Page
35	25	Emlux Discrete	—	166
35	85	Infinia Mini	—	120
36	20	Project 50	Open	110
36	20	Project 50	Baffle	110
42	8	Via	Flush	148
42	8	Camino	Flat	158
46	17	Project 50	Gimbal	110
60	30	2ube Pendant	Recessed mono	140
70	75	Project 90 Open	625lm	98
70	105	Project 90 Open	925lm	98
70	75	Project 90 Gimbal	625lm	102
70	105	Project 90 Gimbal	925lm	102
75	105	Project 90 Cone	625lm	100
75	140	Project 90 Cone	925lm	100
75	105	Project 90 Wallwash	625lm	104
75	140	Project 90 Wallwash	925lm	104
75	95	Proseal F	625lm	108
75	130	Proseal F	925lm	108
80	110	Infinia	Round, Round Trimless, 900lm & 1200lm	116
80 x 80	110	Infinia	Square, Square Trimless, 900lm & 1200lm	116
90	30	Disk Pendant	—	142
100	130	Infinia	Round, 2200lm	116
100	130	Infinia	Round Trimless, 2200lm	116
100 x 100	130	Infinia	Square, 2200lm	116
100 x 100	130	Infinia	Square Trimless, 2200lm	116
110	45	Twizzle	—	96
120	110	Arc	—	126
125	75	Highlux Fixed	—	130
125	165	Infinia	Round, 2600lm	132
125	165	Infinia	Round Trimless, 2600lm	116
125 x 125	165	Infinia	Square, 2600lm	116
125 x 125	165	Infinia	Square Trimless, 2600lm	116
135	95	Highlux Gimbal	—	132
150	40	Hexseal	2000lm	114

Index by product code

Product code	Product range name	Page
3	Ceiling Adaptor Rings	138
B	Biline	78
BU	Uniseal	144
D0	Project 50	112
D102	Twizzle	98
D104	Twizzle	98
D100	Project 90 Open	100
D101	Project 90 Open	100
D12	Project 90 Gimbal	104
D13	Project 90 Wallwash	106
D15	Project 90 Cone	102
D16	Project 90 Cone	102
D17	Project 90 Cone	102
D18	Proseal F	110
D68	Twinlux Low Glare	134
D75	Twinlux Low Glare	132
D78	Twinlux Low Glare	134
DA	Arc	126
DFL	Framelight Mini	108
DFS	Framelight	128
DH	Hexseal	118
DJ1	Highlux Fixed	130
DJ2	Highlux Gimbal	132
DI	Casambi Switches	136
DLE	Lightseal	124
DR1	Infinia Mini	120
DR2	Infinia	120
DR3	Infinia	120
DR4	Infinia	120
DRT	Infinia	130
DS200	Highlux Surface	120
DS209	Infinia	120
DS21	Infinia	120
DS3	Infinia	120
DS4	Infinia	

Product code	Product range name	Page
DST	Infinia	120
E1	Emlux Sign	176
E2	Emlux Sign	176
E4	Emlux Sign	176
EMLUX1	Emlux Discrete	172
EMLUX2	Emlux Duo	168
EMLUX3	Emlux Twinspot	170
EMLUX4	Emlux Blade	174
ES	Signspot	158
F	Fire Hoods	114
HC	Probeam Select	40
HL	Pathfinder	162
L1	Linkline	82
L2	Linkline	82
L4	Linkline	82
L9	Linkline	82
LED21	Via / Camino	154 / 164
LED2C	Camino	164
LED2D	Via	154
LED2E	Via	154
LED2FLA	Camino	164
LED2FLU	Via	154
LED2S	Camino	164
LEDP	Marktrack 24V / Via / Camino	58 / 154 / 164
LN3	Linia Blade T	68
LN5	Linia Blade T	68
LN8	Linia	80
LR	Linia Blade R	66
LS	Linia Blade S	62
LT	Revolva / Biline	76 / 78
P11	Disk Pendant	148
P12	Ambit	142

Product code	Product range name	Page
P22	Disk Pendant	148
P25	Ambit	142
P33	Disk Pendant	148
P38	Ambit	142
PS	Project 50	112
R	Revolva	76
S	Signled	160
T1	1-Circuit 230V	90
T2	1-Circuit 230V	90
T30	Marktrack 24V	58
T31	Topspot E27	56
T32-	1-Circuit 230V	90
T321	Gridspot	34
T322	Gridspot	34
T323	Gridspot	34
T324	Gridspot	34
T325	Rocket E27	54
T326	Rocket E27	54
T328	Rocket E27	54
T33-	1-Circuit 230V	90
T331	Gridspot Anti-Glare	36
T332	Gridspot Anti-Glare	36
T333	Gridspot Anti-Glare	36
T334	Gridspot Anti-Glare	36
T34	Lumapar	50
T35(1-Circuit 230V	90
T351	Probeam	46
T352	Probeam Select	40
T372	Floodline	70
T373	Floodline	70
T374	Floodline	70
T378	Floodline	70
T37F	1-Circuit 230V	90

Product code	Product range name	Page
T38-	1-Circuit 230V	90
T38-C	CLEVR	88
T39	1-Circuit 230V	90
T4-	1-Circuit 230V	90
T41	Topspot E27	56
T421	Gridspot	34
T422	Gridspot	34
T423	Gridspot	34
T424	Gridspot	34
T425	Rocket E27	54
T426	Rocket E27	54
T428	Rocket E27	54
T43	Gridspot Anti-Glare	36
T44	Lumapar	50
T451	Probeam	46
T452	Probeam Select	40
T47	Floodline	70
T8	1-Circuit 230V	90
TC	2ube Pendant	146
TD	1-Circuit 230V	90
TF	Probeam Frame	44
TK	Torp	30
TL	Rotaspot	42
TM	Lumapar GU10	52
TP31	Topspot E27	56
TP32	Rocket E27	54
TP34	Lumapar	50
TP41	Topspot E27	56
TP42	Rocket E27	54
TP44	Lumapar	50
TQ31	Quadroled	74
TQ33	Quadroled Linear	72
TQ39	Quadroled Linear	72

Product code	Product range name	Page
TR	Robospot	42
TS1	3-Circuit 230V	92
TS21	3-Circuit 230V	92
TS23	3-Circuit 230V	92
TS24	3-Circuit 230V	92
TS29	3-Circuit 230V / Control Track 230V	92 / 94
TS32	3-Circuit 230V / Control Track 230V	92 / 94
TS34	3-Circuit 230V	92
TS35	3-Circuit 230V	92
TS36	3-Circuit 230V	92
TS37	3-Circuit 230V	92
TS38	3-Circuit 230V	92
TS39	3-Circuit 230V	92
TS40	3-Circuit 230V	92
TS41	3-Circuit 230V / Control Track 230V	92 / 94
TS410	3-Circuit 230V	92
TS42	3-Circuit 230V	92
TS43	3-Circuit 230V	92
TS44	3-Circuit 230V	92
TS6	Control Track 230V	94
TSC	Control Track 230V	94
TSF	3-Circuit 230V	92
TSP	3-Circuit 230V / Control Track 230V	92 / 94
TSV	3-Circuit 230V / Control Track 230V	92 / 94
TX	Chameleon	38
TZ	Concepta	32
U2	Disk Wall	150
U3	Upline	152

Summary

We go to great lengths to ensure that the **environment** you envisage is the effect you achieve.

At **Illuma**, we are dedicated to providing the highest quality lighting solutions /

Our in-house design and product development teams work tirelessly to ensure that every product we create meets our rigorous standards of excellence.

This commitment to **quality** is evident in every aspect of our operations, from sourcing the latest and highest quality materials to designing innovative and award-winning products that set the industry standard.

We understand that our customers demand the very best, and we are committed to meeting their needs /

That's why we put our products through rigorous **testing** to ensure that they meet the highest standards of quality and performance.

We test our products both internally and externally, and we stand behind them with a **5-year** guarantee.

Our commitment to quality is further demonstrated by our adherence to the **ISO 9001** quality assurance system /

We believe that establishing and maintaining an effective **assurance** system is essential to delivering the highest quality products and services to our customers.

That's why we are proud to comply with the **ISO 9001** system, and we believe that it underscores our commitment to our customers.

The lighting industry is constantly changing. That's why we invest in research and development, manufacturing, distribution, human capital, and training /

We understand that unique lighting solutions require a unique team with the technical knowledge to drive our business forward and source **better solutions** for our ever-more demanding environments and market conditions worldwide.

We take pride in being a **British manufacturer**, and we are committed to delivering exceptional products and services to our customers /

We strive to **exceed** expectations in everything we do, and we are always looking for ways to improve our efficiency and performance.

By maximising the efficiency and performance of our products, **we aim** to better serve our customers' requirements and provide them with the very best lighting solutions available /

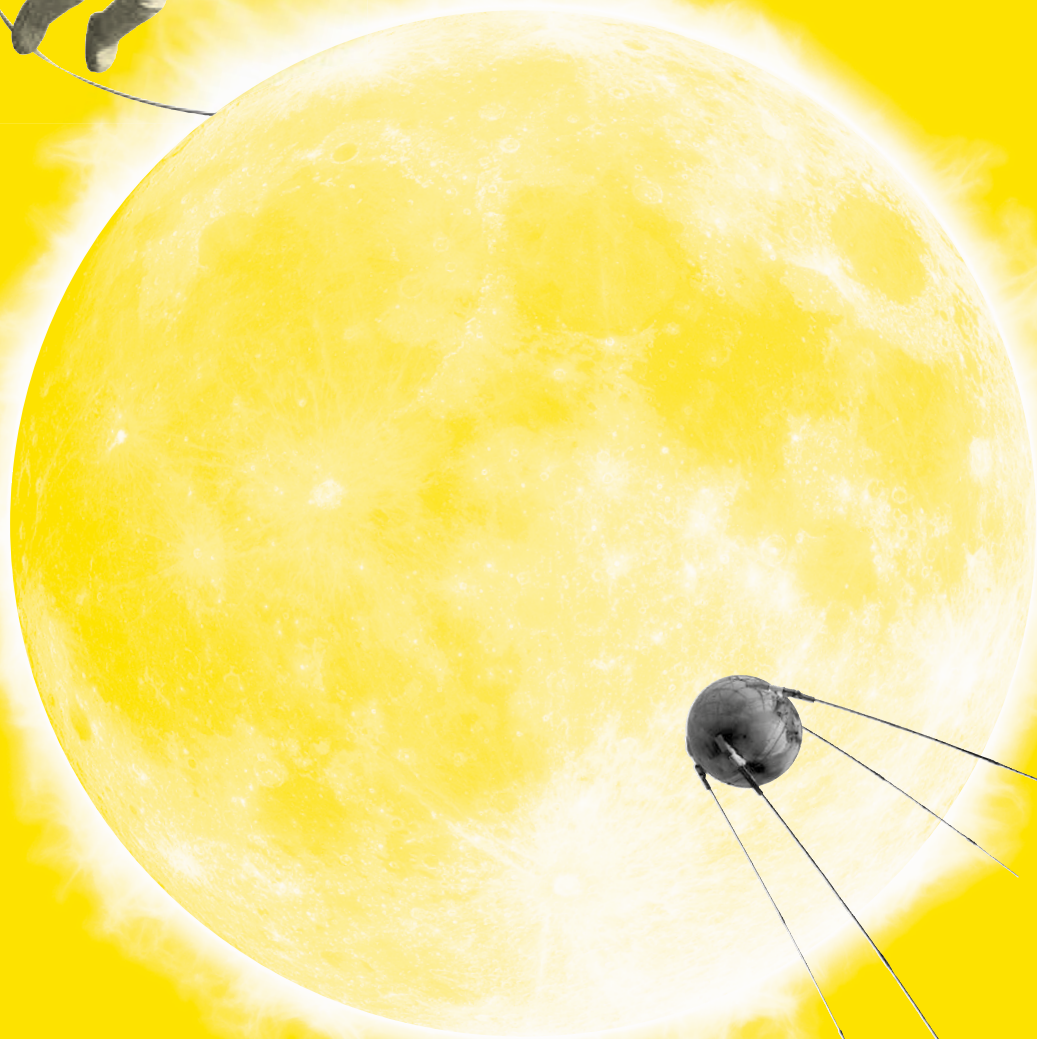



Sills Road
 Willow Farm Business Park
 Castle Donington
 Derbyshire
 DE74 2US
 United Kingdom

///indoors.idea.louder

T +44 (0) 1332 818 200

F +44 (0) 1332 818 222

E sales@illumina.co.uk

www.illumina.co.uk



Visit illumina.co.uk G/BF

